

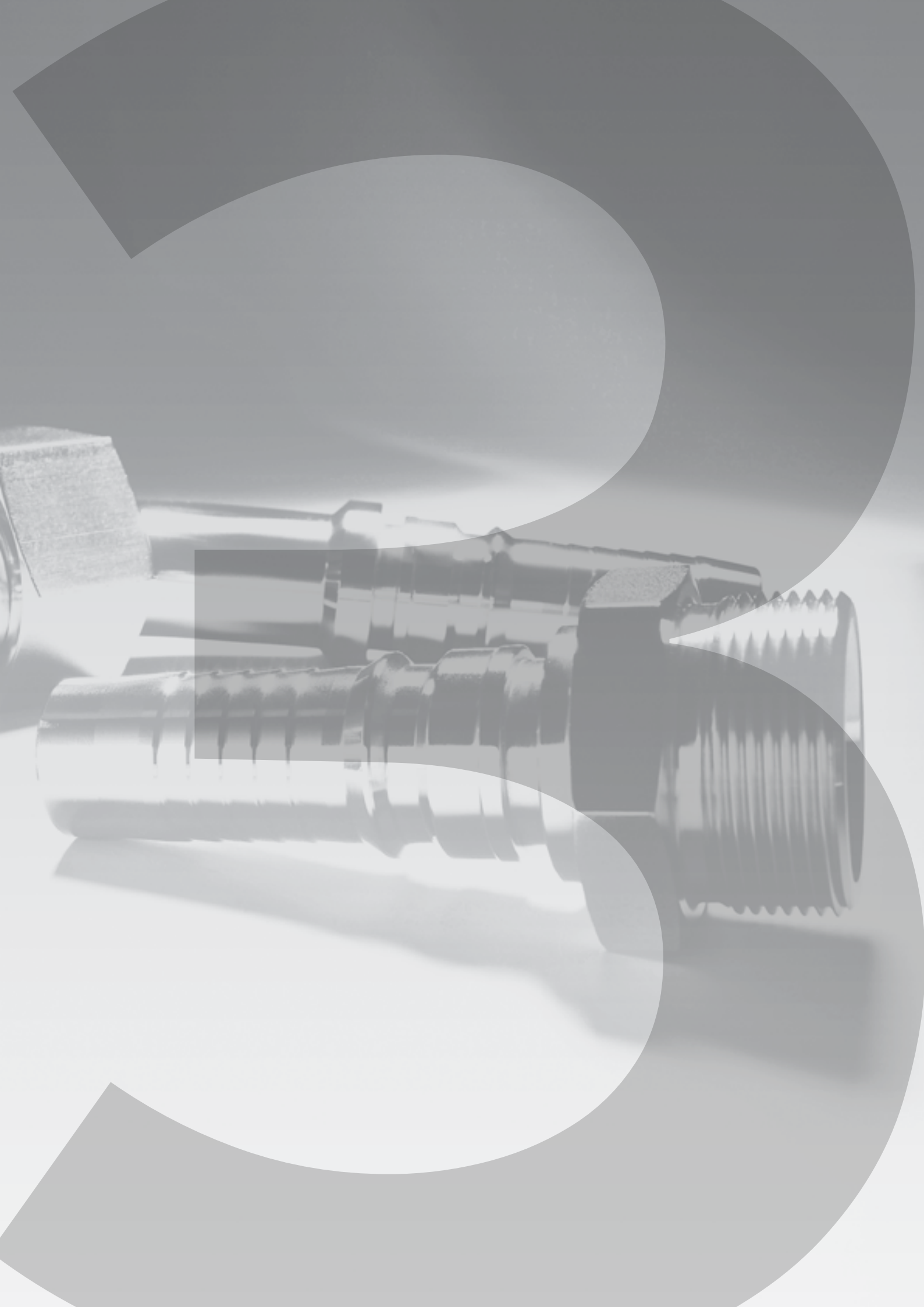











Interlock hose inserts



3



	Product Groups	Page
	Interlock ferrules	
	Ferrules - P4-I	3.02
	Ferrules - P6-I	3.03
	Ferrules - P7-I	3.04
	Interlock fittings - I-SFL & I-SFS (SAE flange)	
	Straight	3.05
	45°-Elbow	3.06
	90°-Elbow	3.07
	Interlock fittings - I-DKOL (metric DIN 2353 L-series female)	
	Straight	3.08
	45°-Elbow	3.09
	90°-Elbow	3.10
	Interlock fittings - I-DKOS (metric DIN 2353 S-series female)	
	Straight	3.11
	45°-Elbow	3.12
	90°-Elbow	3.13
	Interlock fittings - I-DKJ (JIC female)	
	Straight	3.14
	45°-Elbow	3.15
	90°-Elbow	3.16
	Interlock fittings - I-DKOR (BSPP swivel female with O-ring)	
	Straight	3.17
	45°-Elbow	3.18
	90°-Elbow	3.19
	Interlock fittings - I-CES (DIN 2353 compression male)	3.20
	Interlock fittings - I-AGR (BSPP 60° coned male)	3.21
	Interlock fittings - I-AGJ (37° JIC male)	3.22
	Interlock fittings - I-AGN (NPT male)	3.23

Interlock series, for high pressures.

For use with 4SP, 4SH or R12 hydraulic hose, depending on size.

Please check below table.

For use with Interlock hose inserts pp. 3.05-3.23 only.

Hoses must be skived internally and externally.

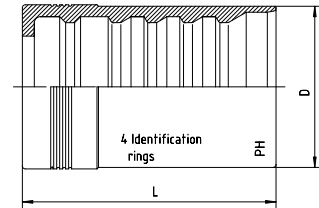

3

Hose DN	Bore in.	For Hose Type		Part code	
		D	L		
19	3/4"	38	56	4 SP + 4 SH	P4-I-DN 19
25	1"	46	75	4 SP + 4 SH + R12	P4-I-DN 25
31	1 1/4"	55	85	4 SH	P4-I-DN 31
38	1 1/2"	64	100	4 SH	P4-I-DN 38
51	2"	78	103	4 SH	P4-I-DN 51

Interlock Ferrules

BOOK INDEX

SECTION INDEX

Interlock series, for high pressures.

For use with R13 hydraulic hose.

For use with Interlock hose inserts pp. 3.05-3.23 only.

Hoses must be skived internally and externally.

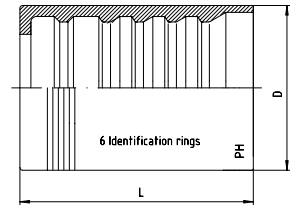

3

Hose DN	Bore in.	D	L	For Hose Type	Part code
19	3/4"	38.0	56	R13	P6-I-DN 19
25	1"	46.0	75	R13	P6-I-DN 25
31	1 1/4"	60.0	85	R13	P6-I-DN 31
38	1 1/2"	70.0	100	R13	P6-I-DN 38
51	2"	84.5	103	R13	P6-I-DN 51

Interlock Ferrules

BOOK INDEX

SECTION INDEX

Interlock series, for high pressures.

For use with R15 hydraulic hose.

For use with Interlock hose inserts pp. 3.05-3.23 only.

Hoses must be skived internally and externally.

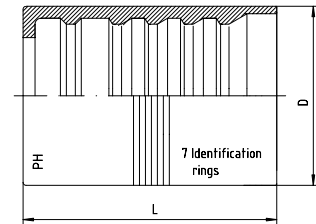

3

Hose DN	Bore in.	D	L	For Hose Type	Part code
19	3/4"	38	56	R15	P7-I-DN 19
25	1"	46	75	R15	P7-I-DN 25
31	1 1/4"	60	85	R15	P7-I-DN 31
38	1 1/2"	70	100	R15	P7-I-DN 38

Interlock series, for high pressures.

SAE ISO flange connection - Straight

I-SFL3 = 3000 psi ("Code 61" flange)

I-SFS6 = 6000 psi ("Code 62" flange)

Specifically designed for use with ferrules

P4, P6 or P7 - pp. 3.02 to 3.04.

Hoses must be skived internally and externally.

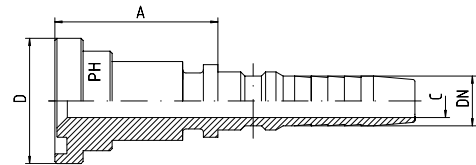

3

3,000 psi series

Hose DN	Bore in.	Flange Dimensions		Approx. Dimensions			Part code
		D	in.	A		C	
19	3/4"	38.1	3/4"	41.0		14.5	I-SFL3-3/4"-DN 19
19	3/4"	44.5	1"	44.5		14.5	I-SFL3-1"-DN 19
25	1"	44.5	1"	52.5		20.0	I-SFL3-1"-DN 25
25	1"	50.8	1 1/4"	53.0		20.0	I-SFL3-1 1/4"-DN 25
31	1 1/4"	50.8	1 1/4"	53.0		25.0	I-SFL3-1 1/4"-DN 31
31	1 1/4"	60.3	1 1/2"	50.5		25.0	I-SFL3-1 1/2"-DN 31
38	1 1/2"	60.3	1 1/2"	77.5		31.5	I-SFL3-1 1/2"-DN 38
38	1 1/2"	71.4	2"	72.0		31.5	I-SFL3-2"-DN 38
51	2"	71.4	2"	72.0		42.0	I-SFL3-2"-DN 51

6,000 psi series

Hose DN	Bore in.	Flange Dimensions		Approx. Dimensions			Part code
		D	in.	A		C	
19	3/4"	41.3	3/4"	52.0		14.5	I-SFS6-3/4"-DN 19
25	1"	41.3	3/4"	47.5		20.0	I-SFS6-3/4"-DN 25
19	3/4"	47.6	1"	44.5		14.5	I-SFS6-1"-DN 19
25	1"	47.6	1"	64.0		20.0	I-SFS6-1"-DN 25
31	1 1/4"	47.6	1"	60.0		20.0	I-SFS6-1"-DN 31
25	1"	54.0	1 1/4"	54.5		20.0	I-SFS6-1 1/4"-DN 25
31	1 1/4"	54.0	1 1/4"	75.0		25.0	I-SFS6-1 1/4"-DN 31
38	1 1/2"	54.0	1 1/4"	105.0		25.0	I-SFS6-1 1/4"-DN 38
31	1 1/4"	63.5	1 1/2"	75.5		25.0	I-SFS6-1 1/2"-DN 31
38	1 1/2"	63.5	1 1/2"	103.0		31.5	I-SFS6-1 1/2"-DN 38
38	1 1/2"	79.4	2"	75.0		31.5	I-SFS6-2"-DN 38
51	2"	79.4	2"	85.0		42.0	I-SFS6-2"-DN 51

Interlock series, for high pressures.

SAE ISO flange connection - swept 45°

I-SFL3 = 3000 psi ("Code 61" flange)

I-SFS6 = 6000 psi ("Code 62" flange)

Specifically designed for use with ferrules

P4, P6 or P7 - pp. 3.02 to 3.04.

Hoses must be skived internally and externally.

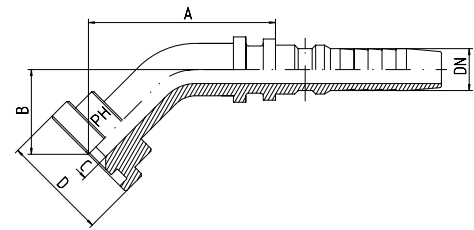

3

3,000 psi series

Hose DN	Bore in.	Flange Dimensions		Approx. Dimensions			Part code
		D	in.	A	B	C	
19	3/4"	38.1	3/4"	87.0	38.0	14.5	I-SFL3-3/4"-45°-DN 19
19	3/4"	44.5	1"	89.0	39.5	14.5	I-SFL3-1"-45°-DN 19
25	1"	44.5	1"	92.0	39.0	20.0	I-SFL3-1"-45°-DN 25
25	1"	50.8	1 1/4"	117.0	44.0	20.0	I-SFL3-1 1/4"-45°-DN 25
31	1 1/4"	50.8	1 1/4"	110.0	45.0	25.0	I-SFL3-1 1/4"-45°-DN 31
31	1 1/4"	60.3	1 1/2"	137.0	46.0	25.0	I-SFL3-1 1/2"-45°-DN 31
38	1 1/2"	60.3	1 1/2"	133.0	49.0	31.0	I-SFL3-1 1/2"-45°-DN 38
38	1 1/2"	71.4	2"	141.5	60.0	31.0	I-SFL3-2"-45°-DN 38
51	2"	71.4	2"	155.0	65.0	41.0	I-SFL3-2"-45°-DN 51

6,000 psi series

Hose DN	Bore in.	Flange Dimensions		Approx. Dimensions			Part code
		D	in.	A	B	C	
19	3/4"	41.3	3/4"	86.0	34.0	14.5	I-SFS6-3/4"-45°-DN 19
25	1"	41.3	3/4"	89.5	41.0	19.0	I-SFS6-3/4"-45°-DN 25
19	3/4"	47.6	1"	90.0	40.0	14.5	I-SFS6-1"-45°-DN 19
25	1"	47.6	1"	92.0	40.0	20.0	I-SFS6-1"-45°-DN 25
25	1"	54.0	1 1/4"	120.0	44.0	20.0	I-SFS6-1 1/4"-45°-DN 25
31	1 1/4"	54.0	1 1/4"	110.0	46.0	25.0	I-SFS6-1 1/4"-45°-DN 31
31	1 1/4"	63.5	1 1/2"	137.0	48.0	25.0	I-SFS6-1 1/2"-45°-DN 31
38	1 1/2"	63.5	1 1/2"	133.0	48.0	31.0	I-SFS6-1 1/2"-45°-DN 38
38	1 1/2"	79.4	2"	143.0	65.0	31.0	I-SFS6-2"-45°-DN 38
51	2"	79.4	2"	155.0	65.0	41.0	I-SFS6-2"-45°-DN 51

Interlock series, for high pressures.

SAE ISO flange connection - swept 90°

I-SFL3 = 3000 psi ("Code 61" flange)

I-SFS6 = 6000 psi ("Code 62" flange)

Specifically designed for use with ferrules

P4, P6 or P7 - pp. 3.02 to 3.04.

Hoses must be skived internally and externally.

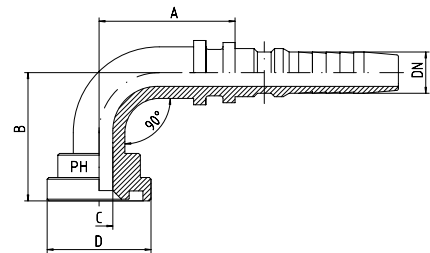

3

3,000 psi series

Hose DN	Bore in.	Flange Dimensions		Approx. Dimensions			Part code
		D	in.	A	B	C	
19	3/4"	38.1	3/4"	78.0	70.0	14.5	I-SFL3-3/4"-90°-DN 19
19	3/4"	44.5	1"	77.0	71.0	14.5	I-SFL3-1"-90°-DN 19
25	1"	44.5	1"	82.0	75.0	20.0	I-SFL3-1"-90°-DN 25
25	1"	50.8	1 1/4"	105.0	88.0	20.0	I-SFL3-1 1/4"-90°-DN 25
31	1 1/4"	50.8	1 1/4"	102.0	91.5	25.0	I-SFL3-1 1/4"-90°-DN 31
31	1 1/4"	60.3	1 1/2"	123.0	95.0	25.0	I-SFL3-1 1/2"-90°-DN 31
38	1 1/2"	60.3	1 1/2"	122.5	105.0	31.0	I-SFL3-1 1/2"-90°-DN 38
38	1 1/2"	71.4	2"	124.0	121.0	31.0	I-SFL3-2"-90°-DN 38
51	2"	71.4	2"	144.0	137.0	41.0	I-SFL3-2"-90°-DN 51

6,000 psi series

Hose DN	Bore in.	Flange Dimensions		Approx. Dimensions			Part code
		D	in.	A	B	C	
19	3/4"	41.3	3/4"	78.0	67.0	14.5	I-SFS6-3/4"-90°-DN 19
25	1"	41.3	3/4"	80.0	81.5	19.0	I-SFS6-3/4"-90°-DN 25
19	3/4"	47.6	1"	77.0	72.0	14.5	I-SFS6-1"-90°-DN 19
25	1"	47.6	1"	82.0	77.0	20.0	I-SFS6-1"-90°-DN 25
25	1"	54.0	1 1/4"	108.0	90.0	20.0	I-SFS6-1 1/4"-90°-DN 25
31	1 1/4"	54.0	1 1/4"	102.0	93.5	25.0	I-SFS6-1 1/4"-90°-DN 31
31	1 1/4"	63.5	1 1/2"	124.0	96.0	25.0	I-SFS6-1 1/2"-90°-DN 31
38	1 1/2"	63.5	1 1/2"	122.5	107.0	31.0	I-SFS6-1 1/2"-90°-DN 38
38	1 1/2"	79.4	2"	124.0	121.5	31.0	I-SFS6-2"-90°-DN 38
51	2"	79.4	2"	144.0	142.0	41.0	I-SFS6-2"-90°-DN 51

Interlock series, for high pressures.

DIN 2353 metric compression swivel female

L series - straight

ISO 8434-1 / DIN 2353

Specifically designed for use with ferrules

P4, P6 or P7 - pp. 3.02 to 3.04.

Hoses must be skived internally and externally.

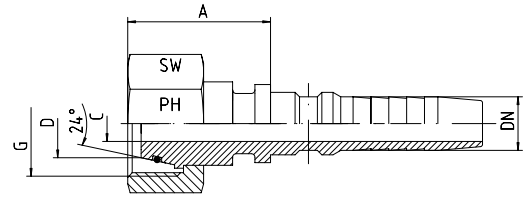

3

Hose DN	Bore in.	Thread G	Tube O.D. D	Approx. Dimensions			Part code
				A	C	SW	
19	3/4"	M 30 x 2	22	38.5	14.5	36	I-DKOL-22-DN 19
25	1"	M 36 x 2	28	38.0	20.0	41	I-DKOL-28-DN 25
31	1 1/4"	M 45 x 2	35	42.0	25.0	50	I-DKOL-35-DN 31
38	1 1/2"	M 52 x 2	42	41.0	31.5	60	I-DKOL-42-DN 38

Interlock series, for high pressures.

DIN 2353 metric compression swivel female

L series - swept 45°

ISO 8434-1 / DIN 2353

Specifically designed for use with ferrules

P4, P6 or P7 - pp. 3.02 to 3.04.

Hoses must be skived internally and externally.

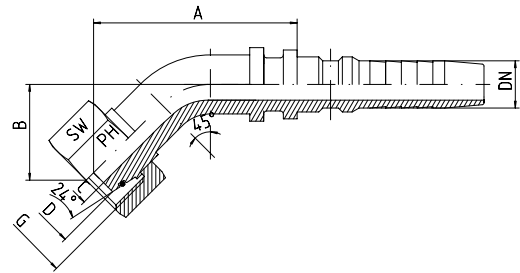

3

Hose DN	Bore in.	Thread G	Tube O.D. D	Approx. Dimensions				Part code
				A	B	C	SW	
19	3/4"	M 30 x 2	22	95	45	14.5	36	I-DKOL-22-45°-DN 19
25	1"	M 36 x 2	28	102	50	20.0	41	I-DKOL-28-45°-DN 25
31	1 1/4"	M 45 x 2	35	120	50	25.0	50	I-DKOL-35-45°-DN 31
38	1 1/2"	M 52 x 2	42	140	61	31.0	60	I-DKOL-42-45°-DN 38

Interlock series, for high pressures.

DIN 2353 metric compression swivel female

L series - swept 90°

ISO 8434-1 / DIN 2353

Specifically designed for use with ferrules

P4, P6 or P7 - pp. 3.02 to 3.04.

Hoses must be skived internally and externally.

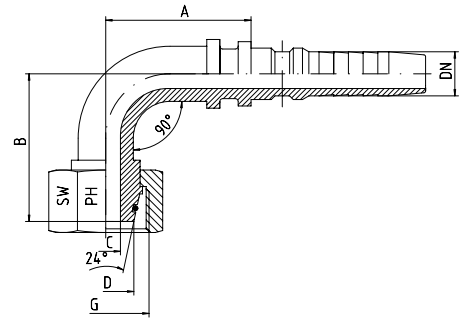

3

Hose DN	Bore in.	Thread G	Tube O.D. D	Approx. Dimensions				Part code
				A	B	C	SW	
19	3/4"	M 30 x 2	22	78.5	80	14.5	36	I-DKOL-22-90°-DN 19
25	1"	M 36 x 2	28	87.0	92	20.0	41	I-DKOL-28-90°-DN 25
31	1 1/4"	M 45 x 2	35	103.0	98	25.0	50	I-DKOL-35-90°-DN 31
38	1 1/2"	M 52 x 2	42	124.0	117	31.0	60	I-DKOL-42-90°-DN 38

Interlock series, for high pressures.

DIN 2353 metric compression swivel female

S series - straight

ISO 8434-1 / DIN 2353

Specifically designed for use with ferrules

P4, P6 or P7 - pp. 3.02 to 3.04.

Hoses must be skived internally and externally.

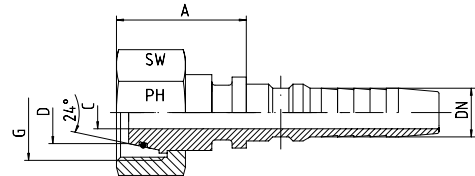

3

Hose DN	Bore in.	Thread G	Tube O.D. D	Approx. Dimensions			Part code
				A	C	SW	
19	3/4"	M 30 x 2	20	34.5	14.5	36	I-DKOS-20-DN 19
19	3/4"	M 36 x 2	25	41.0	14.5	46	I-DKOS-25-DN 19
25	1"	M 36 x 2	25	38.5	20.0	46	I-DKOS-25-DN 25
25	1"	M 42 x 2	30	43.5	20.0	50	I-DKOS-30-DN 25
31	1 1/4"	M 42 x 2	30	43.0	23.0	50	I-DKOS-30-DN 31
31	1 1/4"	M 52 x 2	38	48.5	25.0	60	I-DKOS-38-DN 31
38	1 1/2"	M 52 x 2	38	41.0	28.0	60	I-DKOS-38-DN 38
38	1 1/2"	M 68 x 2	50	51.5	31.5	80	I-DKOS-50-DN 38

DIN 2353 / ISO 8434-1 24° Swivel Female Interlock Insert

BOOK INDEX

SECTION INDEX

Interlock series, for high pressures.

DIN 2353 metric compression swivel female

S series - swept 45°

ISO 8434-1 / DIN 2353

Specifically designed for use with ferrules

P4, P6 or P7 - pp. 3.02 to 3.04.

Hoses must be skived internally and externally.

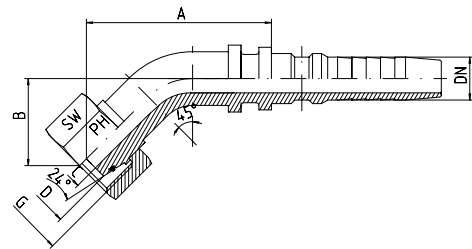

3

Hose DN	Bore in.	Thread G	Tube O.D. D	Approx. Dimensions				Part code
				A	B	C	SW	
19	3/4"	M 30 x 2	20	100	45	14.5	36	I-DKOS-20-45°-DN 19
19	3/4"	M 36 x 2	25	90	40	14.5	46	I-DKOS-25-45°-DN 19
25	1"	M 36 x 2	25	103	52	20.0	46	I-DKOS-25-45°-DN 25
25	1"	M 42 x 2	30	97	43	20.0	50	I-DKOS-30-45°-DN 25
31	1 1/4"	M 52 x 2	38	117	52	25.0	60	I-DKOS-38-45°-DN 31
38	1 1/2"	M 68 x 2	50	136	53	31.0	80	I-DKOS-50-45°-DN 38

Interlock series, for high pressures.

DIN 2353 metric compression swivel female

S series - swept 90°

ISO 8434-1 / DIN 2353

Specifically designed for use with ferrules

P4, P6 or P7 - pp. 3.02 to 3.04.

Hoses must be skived internally and externally.

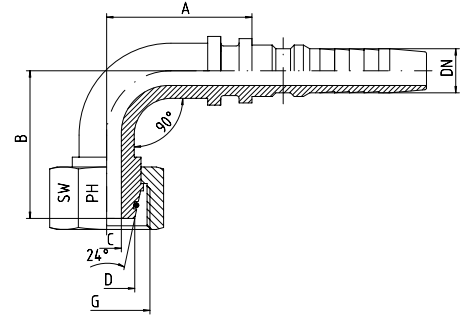

3

Hose DN	Bore in.	Thread G	Tube O.D. D	Approx. Dimensions				Part code
				A	B	C	SW	
19	3/4"	M 30 x 2	20	78.5	83.0	14.5	36	I-DKOS-20-90°-DN 19
19	3/4"	M 36 x 2	25	75.0	76.0	14.5	46	I-DKOS-25-90°-DN 19
25	1"	M 36 x 2	25	84.0	95.5	20.0	46	I-DKOS-25-90°-DN 25
25	1"	M 42 x 2	30	84.0	83.0	20.0	50	I-DKOS-30-90°-DN 25
31	1 1/4"	M 52 x 2	38	103.0	101.0	25.0	60	I-DKOS-38-90°-DN 31
38	1 1/2"	M 68 x 2	50	125.0	111.0	31.0	80	I-DKOS-50-90°-DN 38

JIC 37° Swivel Female Interlock Insert

BOOK INDEX

SECTION INDEX

Interlock series, for high pressures.

37° JIC swivel female - straight

ISO 8434-2 / J514

Specifically designed for use with ferrules

P4, P6 or P7 - pp. 3.02 to 3.04.

Hoses must be skived internally and externally.

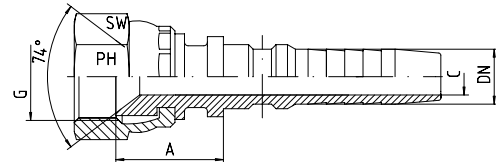

3

Hose DN	Bore in.	Thread G = UN	Approx. Dimensions			Part code
			A	C	SW	
19	3/4"	1 1/16"-12	35.0	14.5	32	I-DKJ-1 1/16"-DN 19
19	3/4"	1 5/16"-12	34.0	14.5	41	I-DKJ-1 5/16"-DN 19
25	1"	1 5/16"-12	34.0	20.0	41	I-DKJ-1 5/16"-DN 25
25	1"	1 5/8"-12	27.0	20.0	50	I-DKJ-1 5/8"-DN 25
31	1 1/4"	1 5/8"-12	37.0	25.0	50	I-DKJ-1 5/8"-DN 31
31	1 1/4"	1 7/8"-12	33.0	25.0	60	I-DKJ-1 7/8"-DN 31
38	1 1/2"	1 7/8"-12	41.5	31.5	60	I-DKJ-1 7/8"-DN 38
38	1 1/2"	2 1/2"-12				I-DKJ-2 1/2"-DN 38
51	2"	2 1/2"-12	67.5	42.0	70	I-DKJ-2 1/2"-DN 51

JIC 37° Swivel Female Interlock Insert

BOOK INDEX

SECTION INDEX

Interlock series, for high pressures.

37° JIC swivel female - swept 45°

ISO 8434-2 / J514

Specifically designed for use with ferrules

P4, P6 or P7 - pp. 3.02 to 3.04.

Hoses must be skived internally and externally.

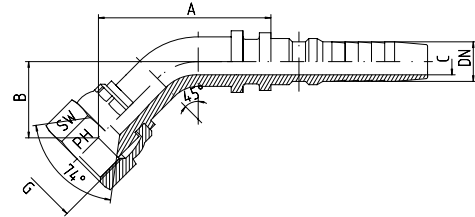

3

Hose DN	Bore in.	Thread G = UN	Approx. Dimensions				Part code
			A	B	C	SW	
19	3/4"	1 1/16"-12	93.0	37.5	14.5	32	I-DKJ-1 1/16"-45°-DN 19
19	3/4"	1 5/16"-12	93.0	43.5	14.5	41	I-DKJ-1 5/16"-45°-DN 19
25	1"	1 5/16"-12	101.0	47.0	20.0	41	I-DKJ-1 5/16"-45°-DN 25
25	1"	1 5/8"-12	123.0	51.0	20.0	50	I-DKJ-1 5/8"-45°-DN 25
31	1 1/4"	1 5/8"-12	116.5	49.0	25.0	50	I-DKJ-1 5/8"-45°-DN 31
31	1 1/4"	1 7/8"-12	146.0	52.0	25.0	60	I-DKJ-1 7/8"-45°-DN 31
38	1 1/2"	1 7/8"-12	130.0	50.0	31.0	60	I-DKJ-1 7/8"-45°-DN 38
38	1 1/2"	2 1/2"-12					I-DKJ-2 1/2"-45°-DN 38
51	2"	2 1/2"-12	166.5	78.0	41.0	70	I-DKJ-2 1/2"-45°-DN 51

JIC 37° Swivel Female Interlock Insert

BOOK INDEX

SECTION INDEX

Interlock series, for high pressures.

37° JIC swivel female - swept 90°

ISO 8434-2 / J514

Specifically designed for use with ferrules

P4, P6 or P7 - pp. 3.02 to 3.04.

Hoses must be skived internally and externally.

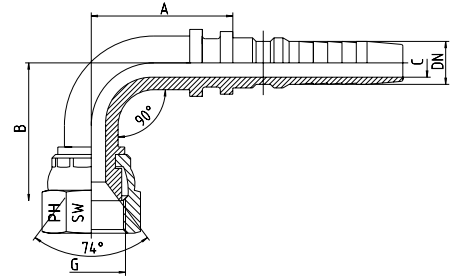

3

Hose DN	Bore in.	Thread G = UN	Approx. Dimensions				Part code
			A	B	C	SW	
19	3/4"	1 1/16"-12	79	72.0	14.5	32	I-DKJ-1 1/16"-90°-DN 19
19	3/4"	1 5/16"-12	78	79.0	14.5	41	I-DKJ-1 5/16"-90°-DN 19
25	1"	1 5/16"-12	85	86.0	20.0	41	I-DKJ-1 5/16"-90°-DN 25
25	1"	1 5/8"-12	107	93.0	20.0	50	I-DKJ-1 5/8"-90°-DN 25
31	1 1/4"	1 5/8"-12	103	96.0	25.0	50	I-DKJ-1 5/8"-90°-DN 31
31	1 1/4"	1 7/8"-12	125	98.0	25.0	60	I-DKJ-1 7/8"-90°-DN 31
38	1 1/2"	1 7/8"-12	122	107.0	31.0	60	I-DKJ-1 7/8"-90°-DN 38
38	1 1/2"	2 1/2"-12					I-DKJ-2 1/2"-90°-DN 38
51	2"	2 1/2"-12	145	151.5	41.0	70	I-DKJ-2 1/2"-90°-DN 51

BSPP 60° Swivel Female (with O-ring) Interlock Insert

BOOK INDEX

SECTION INDEX

Interlock series, for high pressures.

BSPP O-ring 60° coned swivel female - straight

Specifically designed for use with ferrules

P4, P6 or P7 - pp. 3.02 to 3.04.

Hoses must be skived internally and externally.

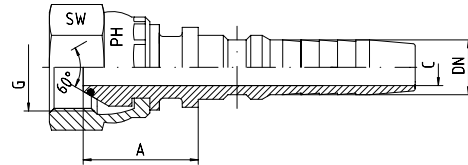

3

Hose DN	Bore in.	Thread G	Approx. Dimensions			Part code
			A	C	SW	
19	3/4"	3/4"-14	32	14.5	32	I-DKOR-3/4"-DN 19
25	1"	1"-11	39	20.0	41	I-DKOR-1"-DN 25
31	1 1/4"	1 1/4"-11	42	25.0	50	I-DKOR-1 1/4"-DN 31
38	1 1/2"	1 1/2"-11	40	31.5	60	I-DKOR-1 1/2"-DN 38
51	2"	2"-11	39	42.0	70	I-DKOR-2"-DN 51

BSPP 60° Swivel Female (with O-ring) Interlock Insert

BOOK INDEX

SECTION INDEX

Interlock series, for high pressures.

BSPP O-ring 60° coned swivel female - swept 45°

Specifically designed for use with ferrules

P4, P6 or P7 - pp. 3.02 to 3.04.

Hoses must be skived internally and externally.

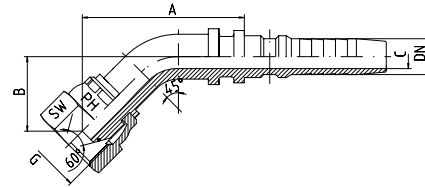

3

Hose DN	Bore in.	Thread G	Approx. Dimensions				Part code
			A	B	C	SW	
19	3/4"	3/4"-14	90	39	14.5	32	I-DKOR-3/4"-45°-DN 19
25	1"	1"-11	97	46	20.0	41	I-DKOR-1"-45°-DN 25
31	1 1/4"	1 1/4"-11	117	52	25.0	50	I-DKOR-1 1/4"-45°-DN 31
38	1 1/2"	1 1/2"-11	134	49	31.0	60	I-DKOR-1 1/2"-45°-DN 38
51	2"	2"-11	170	81	41.0	70	I-DKOR-2"-45°-DN 51

BSPP 60° Swivel Female (with O-ring) Interlock Insert

BOOK INDEX

SECTION INDEX

Interlock series, for high pressures.

BSPP O-ring 60° coned swivel female - swept 90°

Specifically designed for use with ferrules

P4, P6 or P7 - pp. 3.02 to 3.04.

Hoses must be skived internally and externally.

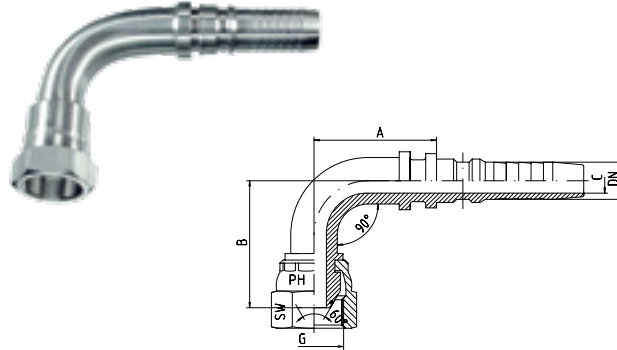

3

Hose DN	Bore in.	Thread G	Approx. Dimensions				Part code
			A	B	C	SW	
19	3/4"	3/4"-14	77	75	14.5	32	I-DKOR-3/4"-90°-DN 19
25	1"	1"-11	83	85	20.0	41	I-DKOR-1"-90°-DN 25
31	1 1/4"	1 1/4"-11	103	100	25.0	50	I-DKOR-1 1/4"-90°-DN 31
38	1 1/2"	1 1/2"-11	118	110	31.0	60	I-DKOR-1 1/2"-90°-DN 38
51	2"	2"-11	146	152	41.0	70	I-DKOR-2"-90°-DN 51

Interlock series, for high pressures.

DIN 2353 metric compression male

S series - straight

ISO 8434-1 / DIN 2353

Specifically designed for use with ferrules

P4, P6 or P7 - pp. 3.02 to 3.04.

Hoses must be skived internally and externally.

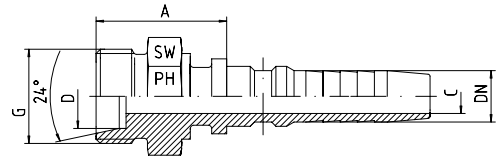

3

Hose DN	Bore in.	Thread G	Tube O.D. D	Approx. Dimensions			Part code
				A	C	SW	
19	3/4"	M 30 x 2	20	37.5	14.5	32	I-CES-20-DN 19
19	3/4"	M 36 x 2	25	36.0	14.5	36	I-CES-25-DN 19
25	1"	M 36 x 2	25	43.0	20.0	36	I-CES-25-DN 25
25	1"	M 42 x 2	30	40.0	20.0	46	I-CES-30-DN 25
31	1 1/4"	M 52 x 2	38	44.5	25.0	55	I-CES-38-DN 31

BSPP 60° Coned Male Interlock Insert

BOOK INDEX

SECTION INDEX

Interlock series, for high pressures.

BSPP 60° coned male - straight

ISO 8434-6 / BS 5200

Specifically designed for use with ferrules

P4, P6 or P7 - pp. 3.02 to 3.04.

Hoses must be skived internally and externally.

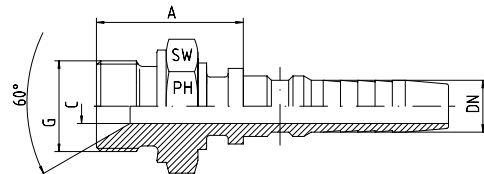

3

Hose DN	Bore in.	Thread G	Approx. Dimensions			Part code
			A	C	SW	
19	3/4"	3/4"-14	40.5	14.5	32	I-AGR-3/4"-DN 19
19	3/4"	1"-11	44.5	14.5	41	I-AGR-1"-DN 19
25	1"	1"-11	48.5	20.0	41	I-AGR-1"-DN 25
31	1 1/4"	1 1/4"-11	44.0	25.0	50	I-AGR-1 1/4"-DN 31
38	1 1/2"	1 1/2"-11	54.0	31.5	55	I-AGR-1 1/2"-DN 38
51	2"	2"-11	52.5	42.0	70	I-AGR-2"-DN 51

JIC 37° Male Interlock Insert

BOOK INDEX

SECTION INDEX

Interlock series, for high pressures.

37° JIC male - straight

ISO 8434-2 / J514

Specifically designed for use with ferrules

P4, P6 or P7 - pp. 3.02 to 3.04.

Hoses must be skived internally and externally.

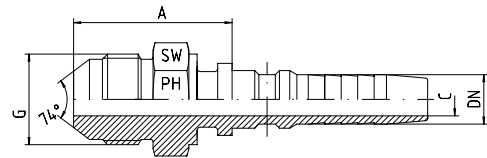

3

Hose DN	Bore in.	Thread G = UN	Approx. Dimensions			Part code
			A	C	SW	
19	3/4"	1 1/16"-12	48.5	14.5	30	I-AGJ-1 1/16"-DN 19
25	1"	1 5/16"-12	48.0	20.0	36	I-AGJ-1 5/16"-DN 25
31	1 1/4"	1 5/8"-12	48.0	25.0	46	I-AGJ-1 5/8"-DN 31
38	1 1/2"	1 7/8"-12	57.0	31.5	50	I-AGJ-1 7/8"-DN 38
51	2"	2 1/2"-12	60.0	42.0	65	I-AGJ-2 1/2"-DN 51

NPT Male Interlock Insert

BOOK INDEX

SECTION INDEX

Interlock series, for high pressures.

NPT 60° coned male - straight

Specifically designed for use with ferrules

P4, P6 or P7 - pp. 3.02 to 3.04.

Hoses must be skived internally and externally.

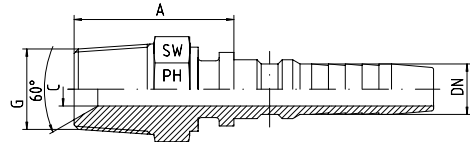

3

Hose DN	Bore in.	Thread G = NPT	Approx. Dimensions			Part code
			A	C	SW	
19	3/4"	3/4"-14	41.0	14.5	30	I-AGN-3/4"-DN 19
19	3/4"	1"-11.5		14.5	36	I-AGN-1"-DN 19
25	1"	1"-11.5	65.5	20.0	36	I-AGN-1"-DN 25
31	1 1/4"	1 1/4"-11.5	53.0	25.0	46	I-AGN-1 1/4"-DN 31
38	1 1/2"	1 1/2"-11.5	60.5	31.0	50	I-AGN-1 1/2"-DN 38
51	2"	2"-11.5	53.0	42.0	65	I-AGN-2"-DN 51











Pegasus
hydraulics

Reusable hose fittings



4



	Product Groups	Page
	Reusable Ferrules	
	Ferrules - SR-P1	4.02
	Ferrules - SR-P2	4.03
	Reusable Standpipe inserts	
	Straight	4.04
	Swept 45°	4.05
	Swept 90°	4.06
	Reusable BSPP swivel 60° female	
	Straight	4.07
	Swept 45°	4.08
	Swept 90°	4.09
	Reusable DIN 2353 / ISO 8434-1 swivel female	
	Straight	4.10
	Swept 45°	4.11
	Swept 90°	4.12
	Reusable DIN 2353 / ISO 8434-1 male compression	4.13
	Reusable BSPP male 60° coned	
	BSP - Male Nipples - 60°-Cone	4.14
	Reusable taper male threads	
	BSP Taper Inserts	4.15
	NPT Inserts	4.16
	37° JIC swivel female	4.17

1.0

Select the correct components according to our documentation.

2.0

Cut the hose to a 90° angle using a hose cutting machine.



3.0

Screw the hose clockwise into the reusable ferrule until it comes to a stop, then back off the hose anti-clockwise 1/2 a turn.



4.0

Lubricate the reusable insert male thread with ASW 040 P High-Tech assembly paste.

IMPORTANT – do not pause whilst screwing the insert into the ferrule.

Screw the reusable insert into the hose until it fully connects with the reusable ferrule.



5.0

Clean the internals of the assembly to the requirement standard.

6.0

Test the connection with the required test pressure for at least 30 seconds.

SR-P1 - For use with non-skive hose.

Please check below table for compatible hose types.

For use with reusable inserts on page 4.05 to 4.18

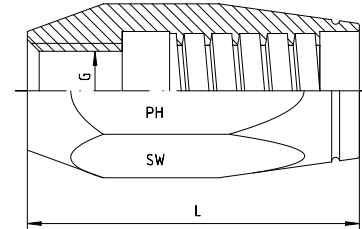

4

Hose DN	Bore in.	Thread G			For Hose Type	Part code
			L	SW		
06	1/4"	7/16"-20 UNF	42.0	19	2 TE, 1 SN, R1AT, Compact 2 SC	SR-P1-DN 06
08	5/16"	1/2"-20 UNF	42.0	19	2 TE, 1 SN, R1AT, Compact 2 SC	SR-P1-DN 08
10	3/8"	9/16"-18 UNF	49.5	24	2 TE, 1 SN, R1AT, Compact 2 SC	SR-P1-DN 10
12	1/2"	5/8"-18 UNF	51.0	27	2 TE, 1 SN, R1AT, Compact 2 SC	SR-P1-DN 12
16	5/8"	3/4"-18 UNF	54.0	30	2 TE, 1 SN, R1AT, Compact 2 SC	SR-P1-DN 16
19	3/4"	7/8"-18 UNF	62.0	36	2 TE, 1 SN, R1AT, Compact 2 SC	SR-P1-DN 19
25	1"	1 3/16"-16 UNF	74.0	41	2 TE, 1 SN, R1AT, Compact 2 SC	SR-P1-DN 25

SR-P2 - For use with non-skive hose.

Please check below table for compatible hose types.

For use with reusable inserts on page 4.05 to 4.18

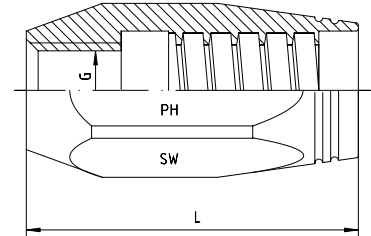

4

Hose DN	Bore in.	Thread G	L	SW	For Hose Type	Part code
06	1/4"	7/16"-20 UNF	42.0	22	3 TE, 2 SN, R2AT	SR-P2-DN 06
08	5/16"	1/2"-20 UNF	42.0	22	3 TE, 2 SN, R2AT	SR-P2-DN 08
10	3/8"	9/16"-18 UNF	49.5	24	3 TE, 2 SN, R2AT	SR-P2-DN 10
12	1/2"	5/8"-18 UNF	51.0	27	3 TE, 2 SN, R2AT	SR-P2-DN 12
16	5/8"	3/4"-18 UNF	57.0	32	3 TE, 2 SN, R2AT	SR-P2-DN 16
19	3/4"	7/8"-18 UNF	62.0	36	3 TE, 2 SN, R2AT	SR-P2-DN 19
25	1"	1 3/16"-16 UNF	74.0	46	3 TE, 2 SN, R2AT	SR-P2-DN 25