













Pegasus
hydraulics

37° JIC fittings to
ISO 8434-2 / J514





	Product Groups	Page
	37° flare JIC fittings function	6.02
	Nuts	6.03
	Sleeves	
	Sleeves – metric	6.04
	Sleeves – imperial	6.05
	37° flare JIC – Straight Coupling	6.06
	37° flare JIC – Equal 90° elbow	6.07
	37° flare JIC – Equal tee	6.08
	37° flare JIC – Swivel female female straight	6.09
	37° flare JIC male stud adapters	
	37° flare JIC male to BSPP male	6.10
	37° flare JIC male to SAE UNF male	6.11
	37° flare JIC male to NPT male	6.12
	37° flare JIC male to BSP taper male	6.13
	37° flare JIC swivel female to BSPP male	6.14
	37° flare JIC – Swivel female to male	
	37° flare JIC – Swivel female to male – form A	6.15
	37° flare JIC – Swivel female to male – form B	6.16
	37° flare JIC – Plugs and Swivel caps	
	37° flare JIC – Male plug	6.17
	37° flare JIC – Swivel female cap	6.18
	37° flare JIC – 90° male stud elbows	
	37° flare JIC male to NPT male 90° elbow	6.19
	37° flare JIC male to BSP taper male 90° elbow	6.20
	37° flare JIC – Bulkheads	
	37° flare JIC – Straight bulkhead	6.21
	37° flare JIC – 90° bulkhead elbow	6.22

	Product Groups	Page
	SAE UNF locknuts	6.23
	37° flare JIC swivel female to NPT male	6.24
	37° flare JIC swivel female to NPT male 90° elbow	6.25
	37° flare JIC swivel female to male 90° elbow	6.26
	37° flare JIC swivel female to male 45° elbow	6.27
	37° flare JIC- Swivel female branch tee	6.28
	37° flare JIC – Swivel female run tee	6.29
	37° flare JIC male to positionable male 90° elbows	
	37° flare JIC male to positionable BSPP male 90° elbow	6.30
	37° flare JIC male to positionable SAE UNF male 90° elbow	6.31
	37° flare JIC male to positionable BSPP male 45° elbow	6.32
	37° flare JIC male to BSPP female pressure gauge connector	6.33
	37° flare JIC male to BSPP female	6.34

37° flare JIC fittings to ISO 8434-2 / J514

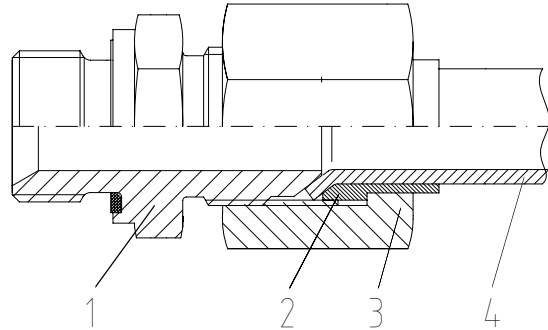

A complete 37° flare JIC fitting to ISO 8434-2 / J514 comprises a fitting body (1), sleeve (2) and nut (3).

The sleeves can be changed to either imperial OD or metric depending on the type of tube used.

During assembly, the pre-flared tube (4) is clamped between the sleeve and the convex 37° flared male cone of the fitting body. The sleeve centres and supports the tube as well as preventing tube rotation, plus it aids in dampening any vibration in the system.

The sleeve does not turn whilst the connection is effected, thereby it does not transmit any torque to the tube. The result is an extremely dependable metallic seal.

We can supply fitting bodies with O-rings incorporated into the male convex 37° flare cone upon request.

Nuts

BOOK INDEX

SECTION INDEX

For 37° flare JIC fittings
to ISO 8434-2 / J514

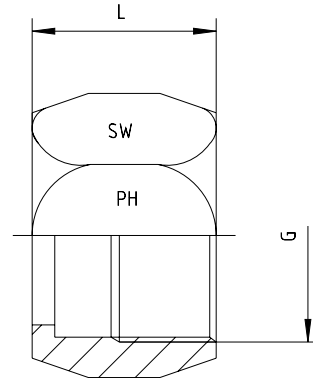

Tube O.D.		Thread G	L	SW	Part code
mm	in.				
6	1/4"	7/16"-20 UNF	15.5	14	M-37-06-04
8	5/16"	1/2"-20 UNF	17.0	17	M-37-08-05
10	3/8"	9/16"-18 UNF	18.3	19	M-37-10-06
12	1/2"	3/4"-16 UNF	21.3	22	M-37-12-08
14, 15, 16	5/8"	7/8"-14 UNF	24.6	27	M-37-16-10
18, 20	3/4"	1 1/16"-12 UN	25.9	32	M-37-20-12
25	1"	1 5/16"-12 UN	28.4	41	M-37-25-16
28, 30, 32	1 1/4"	1 5/8"-12 UN	31.0	50	M-37-30-20
35, 38	1 1/2"	1 7/8"-12 UN	35.8	60	M-37-38-24
50	2"	2 1/2"-12 UN	44.2	75	M-37-50-32

Sleeve – metric

BOOK INDEX

SECTION INDEX

For 37° flare JIC fittings
to ISO 8434-2 / J514

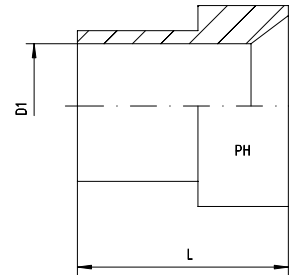

6

Tube O.D. mm	D1 + Tol.	L	Part code
6	6	10.4	DR-37-06
8	8	11.2	DR-37-08
10	10	12.7	DR-37-10
12	12	14.2	DR-37-12
14	14	14.0	DR-37-14
15	15	14.0	DR-37-15
16	16	16.8	DR-37-16
18	18	23.1	DR-37-18
20	20	17.3	DR-37-20
25	25	19.8	DR-37-25
28	28	23.0	DR-37-28
30	30	23.1	DR-37-30
32	32	23.0	DR-37-32
35	35	28.4	DR-37-35
38	38	28.4	DR-37-38
50	50	30.2	DR-37-50

Sleeve – imperial

BOOK INDEX

SECTION INDEX

For 37° flare JIC fittings
to ISO 8434-2 / J514

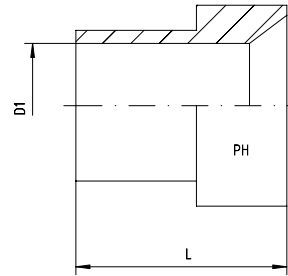

Tube O.D.				Part code	
in.	mm	D1	L		
1/4"	6.35	6.53	10.4		DR-37-1/4"
5/16"	7.94	8.13	11.2		DR-37-5/16"
3/8"	9.52	9.73	12.7		DR-37-3/8"
1/2"	12.70	12.88	14.2		DR-37-1/2"
5/8"	15.88	16.08	16.8		DR-37-5/8"
3/4"	19.05	19.28	17.3		DR-37-3/4"
1"	25.40	25.60	19.8		DR-37-1"
1 1/4"	31.75	32.05	23.1		DR-37-1 1/4"
1 1/2"	38.10	38.40	28.4		DR-37-1 1/2"
2"	50.80	51.21	30.2		DR-37-2"

37° flare JIC – Straight coupling

BOOK INDEX

SECTION INDEX

37° flare JIC fittings

to ISO 8434-2 / J514

Reducers available upon request.

Eg. 20mm to 16mm OD tube =

Part code 1252510-12-10

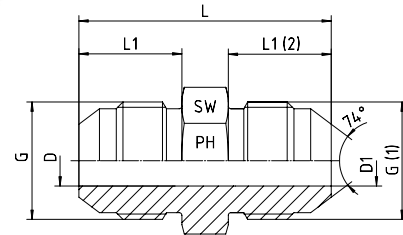

Pressure PN	Tube O.D.		Thread		Approx. Dimensions						Part code
	mm	in.	G	G1	L	L1	L2	D	D1	SW	
350	6	1/4"	7/16"-20 UNF		35.0	14.0		4.5		12	1252510-04-04
350	8	5/16"	1/2"-20 UNF		35.0	14.0		5.0		14	1252510-05-05
350			9/16"-18 UNF	7/16"-20 UNF	35.0	14.1	14.0	7.5	4.0	17	1252510-06-04
350	10	3/8"	9/16"-18 UNF		36.0	14.1		7.5		17	1252510-06-06
350			3/4"-16 UNF	9/16"-18 UNF	38.1	16.7	14.1	9.5	7.5	22	1252510-08-06
350	12	1/2"	3/4"-16 UNF		41.0	16.7		9.5		22	1252510-08-08
350			7/8"-14 UNF	3/4"-16 UNF	45.0	19.3	16.7	12.5	9.5	24	1252510-10-08
350	14, 15, 16	5/8"	7/8"-14 UNF		48.0	19.3		12.5		24	1252510-10-10
350			1 1/16"-12 UN	3/4"-16 UNF	48.0	21.9	16.7	15.0	9.5	27	1252510-12-08
350			1 1/16"-12 UN	7/8"-14 UNF	51.0	21.9	19.3	15.0	12.5	27	1252510-12-10
350	18, 20	3/4"	1 1/16"-12 UN		55.0	21.9		15.0		27	1252510-12-12
280			1 5/16"-12 UN	1 1/16"-12 UN	56.0	23.1	21.9	21.5	15.0	36	1252510-16-12
280	25	1"	1 5/16"-12 UN		57.0	23.1		21.5		36	1252510-16-16
210			1 5/8"-12 UN	1 1/16"-12 UN	56.0	24.3	21.9	27.5	15.0	46	1252510-20-12
210			1 5/8"-12 UN	1 5/16"-12 UN	57.0	24.3	23.1	27.5	21.5	46	1252510-20-16
210	28, 30, 32	1 1/4"	1 5/8"-12 UN		61.5	24.3		27.5		46	1252510-20-20
210			1 7/8"-12 UN	1 5/8"-12 UN	65.0	27.5	24.3	33.0	27.5	50	1252510-24-20
210	35, 38	1 1/2"	1 7/8"-12 UN		70.0	27.5		33.0		50	1252510-24-24
150	50	2"	2 1/2"-12 UN		80.0	33.9		45.0		65	1252510-32-32

37° flare JIC – Equal 90° elbow

BOOK INDEX

SECTION INDEX

37° flare JIC fittings
to ISO 8434-2 / J514

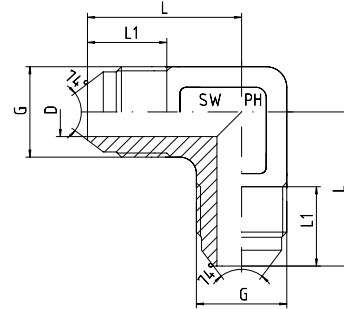

Pressure PN	Tube O.D.		Thread G	Approx. Dimensions				Part code
	mm	in.		L	L1	D	SW	
350	6	1/4"	7/16"-20 UNF	22.5	14.0	4.5	12	1252511-04-04
350	8	5/16"	1/2"-20 UNF	24.0	14.0	6.0	13	1252511-05-05
350	10	3/8"	9/16"-18 UNF	27.0	14.1	7.5	14	1252511-06-06
350	12	1/2"	3/4"-16 UNF	31.0	16.7	10.0	19	1252511-08-08
350	14, 15, 16	5/8"	7/8"-14 UNF	37.5	19.3	12.5	24	1252511-10-10
350	18, 20	3/4"	1 1/16"-12 UN	42.0	21.9	15.0	24	1252511-12-12
280	25	1"	1 5/16"-12 UN	46.0	23.1	21.5	33	1252511-16-16
210	28, 30, 32	1 1/4"	1 5/8"-12 UN	52.5	24.3	27.5	41	1252511-20-20
210	35, 38	1 1/2"	1 7/8"-12 UN	59.0	27.5	33.0	50	1252511-24-24
150	50	2"	2 1/2"-12 UN	77.5	33.9	45.0	65	1252511-32-32

37° flare JIC – Equal tee

BOOK INDEX

SECTION INDEX

37° flare JIC fittings
to ISO 8434-2 / J514

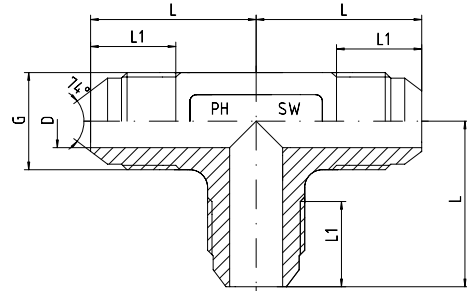

6

Pressure PN	Tube O.D.		Thread G	Approx. Dimensions				Part code
	mm	in.		L	L1	D	SW	
350	6	1/4"	7/16"-20 UNF	22.5	14.0	4.5	12	1252512-04-04-04
350	8	5/16"	1/2"-20 UNF	24.0	14.0	6.0	13	1252512-05-05-05
350	10	3/8"	9/16"-18 UNF	27.0	14.1	7.5	14	1252512-06-06-06
350	12	1/2"	3/4"-16 UNF	31.0	16.7	10.0	19	1252512-08-08-08
350	14, 15, 16	5/8"	7/8"-14 UNF	37.5	19.3	12.5	24	1252512-10-10-10
350	18, 20	3/4"	1 1/16"-12 UN	42.0	21.9	15.5	24	1252512-12-12-12
280	25	1"	1 5/16"-12 UN	46.0	23.1	21.5	33	1252512-16-16-16
210	28, 30, 32	1 1/4"	1 5/8"-12 UN	52.5	24.3	27.5	41	1252512-20-20-20
210	35, 38	1 1/2"	1 7/8"-12 UN	59.0	27.5	33.0	50	1252512-24-24-24
150	50	2"	2 1/2"-12 UN	77.5	33.9	45.0	65	1252512-32-32-32

37° flare JIC - Swivel female female straight

BOOK INDEX

SECTION INDEX

37° flare JIC fittings
to ISO 8434-2 / J514

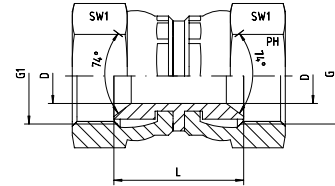

Pressure PN	Tube O.D.		Thread G1	Approx. Dimensions			Part code
	mm	in.		L	D	SW1	
350	6	1/4"	7/16"-20 UNF	21.0	4.0	17	3252511-04-04
350	8	5/16"	1/2"-20 UNF	21.0	5.0	17	3252511-05-05
350	10	3/8"	9/16"-18 UNF	24.0	7.0	19	3252511-06-06
350	12	1/2"	3/4"-16 UNF	25.5	10.0	24	3252511-08-08
350	14, 15, 16	5/8"	7/8"-14 UNF	30.0	12.0	27	3252511-10-10
350	18, 20	3/4"	1 1/16"-12 UN	30.0	15.0	32	3252511-12-12
280	25	1"	1 5/16"-12 UN	35.0	21.0	41	3252511-16-16
210	28, 30, 32	1 1/4"	1 5/8"-12 UN	35.0	27.5	50	3252511-20-20
210	35, 38	1 1/2"	1 7/8"-12 UN	40.0	33.0	55	3252511-24-24

37° flare JIC male to BSPP male

BOOK INDEX

SECTION INDEX

37° flare JIC fittings

to ISO 8434-2 / J514

BSP parallel thread with
Viton soft seal

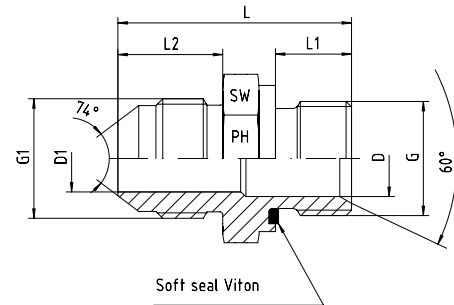

Pressure PN	Tube O.D.		Thread		Approx. Dimensions						Part code G1 x G
	mm	in.	G1 = UNF/UN	G = BSP	L	L1	L2	D	D1	SW	
350	6	1/4"	7/16"-20	1/8"-28	30.0	8	14.0	3.5	3.5	14	1052510-04-02
350	6	1/4"	7/16"-20	1/4"-19	34.0	12	14.0	4.0	4.0	19	1052510-04-04
350	6	1/4"	7/16"-20	3/8"-19	34.5	12	14.0	8.0	4.0	22	1052510-04-06
350	6	1/4"	7/16"-20	1/2"-14	37.5	14	14.0	11.5	4.0	27	1052510-04-08
350	8	5/16"	1/2"-20	1/8"-28	30.0	8	14.0	4.5	4.5	14	1052510-05-02
350	8	5/16"	1/2"-20	1/4"-19	34.0	12	14.0	5.0	5.0	19	1052510-05-04
350	8	5/16"	1/2"-20	3/8"-19	34.5	12	14.0	8.0	5.0	22	1052510-05-06
350	8	5/16"	1/2"-20	1/2"-14	37.5	14	14.0	11.5	5.0	27	1052510-05-08
350	10	3/8"	9/16"-18	1/8"-28	30.0	8	14.0	4.5	6.0	17	1052510-06-02
350	10	3/8"	9/16"-18	1/4"-19	33.0	10	14.0	6.0	6.0	19	1052510-06-04
350	10	3/8"	9/16"-18	3/8"-19	34.5	12	14.0	7.5	7.5	22	1052510-06-06
350	10	3/8"	9/16"-18	1/2"-14	40.0	14	14.0	12.0	7.5	27	1052510-06-08
350	12	1/2"	3/4"-16	1/4"-19	37.0	10	17.0	5.0	9.5	22	1052510-08-04
350	12	1/2"	3/4"-16	3/8"-19	41.0	12	17.0	9.0	9.0	22	1052510-08-06
350	12	1/2"	3/4"-16	1/2"-14	40.5	14	17.0	9.5	9.5	27	1052510-08-08
350	12	1/2"	3/4"-16	3/4"-14	46.0	16	17.0	17.0	9.5	32	1052510-08-12
350	14, 15, 16	5/8"	7/8"-14	3/8"-19	42.5	12	19.5	8.0	12.0	24	1052510-10-06
350	14, 15, 16	5/8"	7/8"-14	1/2"-14	43.0	14	19.5	12.0	12.0	27	1052510-10-08
350	14, 15, 16	5/8"	7/8"-14	5/8"-14	44.5	16	19.5	14.5	12.0	30	1052510-10-10
350	14, 15, 16	5/8"	7/8"-14	3/4"-14	46.0	16	19.5	17.0	12.0	32	1052510-10-12
350	14, 15, 16	5/8"	7/8"-14	1"-11	50.0	18	19.5	22.5	12.0	41	1052510-10-16
350	18, 20	3/4"	1 1/16"-12	3/8"-19	44.5	12	22.0	8.0	15.0	27	1052510-12-06
350	18, 20	3/4"	1 1/16"-12	1/2"-14	50.0	14	22.0	11.5	15.0	27	1052510-12-08
350	18, 20	3/4"	1 1/16"-12	3/4"-14	51.0	16	22.0	15.0	15.0	32	1052510-12-12
350	18, 20	3/4"	1 1/16"-12	1"-11	53.0	18	22.0	22.5	15.0	41	1052510-12-16
350	18, 20	3/4"	1 1/16"-12	1 1/4"-11	56.5	20	22.0	29.0	15.0	50	1052510-12-20
280	25	1"	1 5/16"-12	1/2"-14	51.0	14	23.0	11.5	21.5	36	1052510-16-08
280	25	1"	1 5/16"-12	3/4"-14	53.0	16	23.0	17.5	21.5	36	1052510-16-12
280	25	1"	1 5/16"-12	1"-11	53.5	18	23.0	21.5	21.5	41	1052510-16-16
280	25	1"	1 5/16"-12	1 1/4"-11	57.5	20	23.0	29.0	21.5	50	1052510-16-20
210	25	1"	1 5/16"-12	1 1/2"-11	59.5	22	23.0	33.5	21.0	55	1052510-16-24
210	28, 30, 32	1 1/4"	1 5/8"-12	3/4"-14	56.7	16	24.3	17.0	26.5	46	1052510-20-12
210	28, 30, 32	1 1/4"	1 5/8"-12	1"-11	55.0	18	24.3	23.0	26.5	46	1052510-20-16
210	28, 30, 32	1 1/4"	1 5/8"-12	1 1/4"-11	59.0	20	24.3	29.0	26.5	50	1052510-20-20
210	28, 30, 32	1 1/4"	1 5/8"-12	1 1/2"-11	61.0	22	24.3	33.5	26.5	55	1052510-20-24
150	28, 30, 32	1 1/4"	1 5/8"-12	2"-11	64.3	25	24.3	46.0	26.5	70	1052510-20-32
210	35, 38	1 1/2"	1 7/8"-12	1"-11	60.0	18	27.5	22.5	32.0	50	1052510-24-16
210	35, 38	1 1/2"	1 7/8"-12	1 1/4"-11	62.0	20	27.5	29.0	32.0	50	1052510-24-20
210	35, 38	1 1/2"	1 7/8"-12	1 1/2"-11	64.0	22	27.5	33.5	32.0	55	1052510-24-24
150	35, 38	1 1/2"	1 7/8"-12	2"-11	67.5	23	27.5	46.0	32.0	70	1052510-24-32
150	50	2"	2 1/2"-12	2"-11	76.0	23	33.9	45.0	45.0	70	1052510-32-32

37° flare JIC male to SAE UNF male

BOOK INDEX

SECTION INDEX

37° flare JIC fittings

to ISO 8434-2 / J514

SAE UNF thread to ASA B 1.1-1960

Seal effected by O-ring as per J514

Note: - Adhere to the port requirements for this thread form.

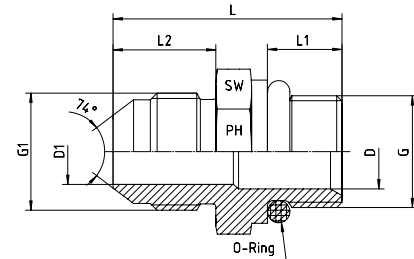

Pressure PN	Tube O.D.		Thread		Approx. Dimensions						Part code G1 x G
	mm	in.	G1 = UNF/UN	G = UNF/UN	L	L1	L2	D	D1	SW	
350	6	1/4"	7/16"-20	7/16"-20	31.0	9.2	14.0	4.5	4.5	17	1052511-04-04
350	8	5/16"	1/2"-20	1/2"-20	31.0	9.2	14.0	6.0	6.0	17	1052511-05-05
350	10	3/8"	9/16"-18	9/16"-18	33.0	10.0	14.0	7.5	7.5	19	1052511-06-06
350	10	3/8"	9/16"-18	3/4"-16	35.5	11.0	14.0	9.5	7.5	24	1052511-06-08
350	12	1/2"	3/4"-16	3/4"-16	38.0	11.0	17.0	9.5	9.5	24	1052511-08-08
350	12	1/2"	3/4"-16	7/8"-14	40.0	12.7	17.0	12.0	9.5	27	1052511-08-10
350	14, 15, 16	5/8"	7/8"-14	3/4"-16	42.0	11.0	19.5	9.5	12.5	27	1052511-10-08
350	14, 15, 16	5/8"	7/8"-14	7/8"-14	43.0	12.7	19.5	12.0	12.0	27	1052511-10-10
350	14, 15, 16	5/8"	7/8"-14	1 1/16"-12	47.0	15.0	19.5	15.0	12.0	32	1052511-10-12
350	18, 20	3/4"	1 1/16"-12	1 1/16"-12	50.0	15.0	22.0	15.0	15.0	32	1052511-12-12
350	18, 20	3/4"	1 1/16"-12	1 5/16"-12	51.0	15.0	22.0	21.5	15.0	41	1052511-12-16
280	25	1"	1 5/16"-12	1 5/16"-12	52.0	15.0	23.0	21.5	21.5	41	1052511-16-16
210	28, 30, 32	1 1/4"	1 5/8"-12	1 5/8"-12	53.0	15.0	24.3	27.5	27.5	50	1052511-20-20
210	35, 38	1 1/2"	1 7/8"-12	1 7/8"-12	56.5	15.0	27.5	33.0	33.0	55	1052511-24-24

37° flare JIC male to NPT male

BOOK INDEX

SECTION INDEX

37° flare JIC fittings to ISO 8434-2 / J514

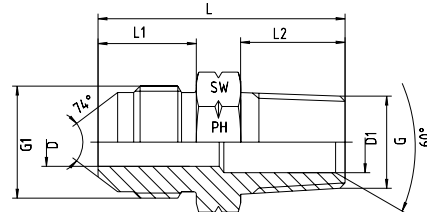

Pressure PN	Tube O.D.		Thread		Approx. Dimensions						Part code G1 x G
	mm	in.	G1 = UNF/UN	G = NPT	L	L1	L2	D	D1	SW	
350	6	1/4"	7/16"-20	1/8"-27	31.0	14.0	10.0	4.0	4.0	12	1252810-04-02
350	6	1/4"	7/16"-20	1/4"-18	36.0	14.0	15.0	4.0	4.0	17	1252810-04-04
350	6	1/4"	7/16"-20	3/8"-18	36.0	14.0	15.3	4.0	9.0	19	1252810-04-06
350	6	1/4"	7/16"-20	1/2"-14	42.0	14.0	20.0	4.0	13.0	22	1252810-04-08
350	8	5/16"	1/2"-20	1/8"-27	30.0	14.0	10.0	4.0	4.0	14	1252810-05-02
350	8	5/16"	1/2"-20	1/4"-18	36.0	14.0	15.0	5.0	5.0	17	1252810-05-04
350	8	5/16"	1/2"-20	3/8"-18	36.0	14.0	15.3	5.0	9.0	19	1252810-05-06
350	8	5/16"	1/2"-20	1/2"-14	42.0	14.0	20.0	5.0	13.0	22	1252810-05-08
350	10	3/8"	9/16"-18	1/8"-27	30.0	14.0	10.0	6.0	4.0	17	1252810-06-02
350	10	3/8"	9/16"-18	1/4"-18	34.0	14.0	15.0	6.0	6.0	17	1252810-06-04
350	10	3/8"	9/16"-18	3/8"-18	34.0	14.0	15.3	6.0	6.0	19	1252810-06-06
350	10	3/8"	9/16"-18	1/2"-14	43.0	14.0	20.0	7.5	13.0	22	1252810-06-08
350	12	1/2"	3/4"-16	1/4"-18	39.0	17.0	15.0	9.0	5.0	19	1252810-08-04
350	12	1/2"	3/4"-16	3/8"-18	39.0	17.0	15.3	9.0	9.0	19	1252810-08-06
350	12	1/2"	3/4"-16	1/2"-14	45.7	17.0	20.0	9.5	9.5	22	1252810-08-08
350	12	1/2"	3/4"-16	3/4"-14	47.2	17.0	20.0	9.5	17.0	27	1252810-08-12
350	14, 15, 16	5/8"	7/8"-14	3/8"-18	42.0	19.5	15.3	12.0	9.0	24	1252810-10-06
350	14, 15, 16	5/8"	7/8"-14	1/2"-14	48.0	19.5	20.0	12.0	12.0	24	1252810-10-08
350	14, 15, 16	5/8"	7/8"-14	3/4"-14	48.2	19.5	20.0	12.0	18.0	27	1252810-10-12
350	18, 20	3/4"	1 1/16"-12	3/8"-18	47.0	22.0	15.3	15.0	9.0	27	1252810-12-06
350	18, 20	3/4"	1 1/16"-12	1/2"-14	52.2	22.0	20.0	15.0	13.5	27	1252810-12-08
350	18, 20	3/4"	1 1/16"-12	3/4"-14	52.3	22.0	20.0	15.0	15.0	27	1252810-12-12
350	18, 20	3/4"	1 1/16"-12	1"-11.5	57.5	22.0	25.0	15.0	21.0	36	1252810-12-16
280	25	1"	1 5/16"-12	1/2"-14	53.2	23.0	20.0	21.0	13.5	36	1252810-16-08
280	25	1"	1 5/16"-12	3/4"-14	53.0	23.0	20.0	21.0	18.0	36	1252810-16-12
280	25	1"	1 5/16"-12	1"-11.5	58.0	23.0	25.0	21.0	21.0	36	1252810-16-16
280	25	1"	1 5/16"-12	1 1/4"-11.5	58.0	23.0	25.5	21.0	31.7	46	1252810-16-20
210	25	1"	1 5/16"-12	1 1/2"-11.5	62.0	23.0	26.0	21.0	32.0	50	1252810-16-24
210	28, 30, 32	1 1/4"	1 5/8"-12	1"-11.5	62.0	24.3	25.0	26.5	21.0	46	1252810-20-16
210	28, 30, 32	1 1/4"	1 5/8"-12	1 1/4"-11.5	62.0	24.3	25.5	26.5	31.7	46	1252810-20-20
210	28, 30, 32	1 1/4"	1 5/8"-12	1 1/2"-11.5	64.8	24.3	26.0	26.5	38.0	50	1252810-20-24
210	35, 38	1 1/2"	1 7/8"-12	1 1/2"-11.5	68.0	27.5	26.0	32.0	32.0	50	1252810-24-24
210	35, 38	1 1/2"	1 7/8"-12	1 1/4"-11.5	66.0	27.5	25.5	31.7	31.7	50	1252810-24-20
150	50	2"	2 1/2"-12	2"-11.5	72.0	33.9	26.0	45.0	45.0	65	1252810-32-32

37° flare JIC male to BSP taper male

BOOK INDEX

SECTION INDEX

37° flare JIC fittings
to ISO 8434-2 / J514

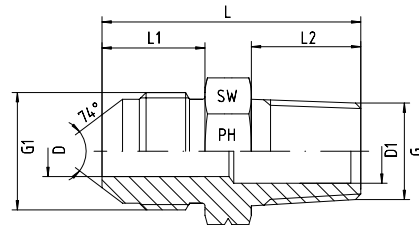

6

Pressure PN	Tube O.D.		Thread		Approx. Dimensions						Part code G1 x G
	mm	in.	G1 = UNF/UN	G = BSPT	L	L1	L2	D	D1	SW	
315	6	1/4"	7/16"-20	1/8"-28	29.0	14.0	8	4.0	4.0	12	1252820-04-02
315	6	1/4"	7/16"-20	1/4"-19	33.0	14.0	12	4.0	4.0	14	1252820-04-04
315	6	1/4"	7/16"-20	3/8"-19	32.7	14.0	12	4.0	9.0	19	1252820-04-06
315	6	1/4"	7/16"-20	1/2"-14	42.0	14.0	20	4.0	13.0	22	1252820-04-08
315	8	5/16"	1/2"-20	1/8"-28	28.0	14.0	8	4.0	4.0	14	1252820-05-02
315	8	5/16"	1/2"-20	1/4"-19	33.0	14.0	12	5.0	5.0	14	1252820-05-04
315	8	5/16"	1/2"-20	3/8"-19	32.7	14.0	12	5.0	9.0	19	1252820-05-06
315	10	3/8"	9/16"-18	1/8"-28	28.0	14.0	8	6.0	4.0	17	1252820-06-02
315	10	3/8"	9/16"-18	1/4"-19	31.0	14.0	12	6.0	6.0	17	1252820-06-04
315	10	3/8"	9/16"-18	3/8"-19	30.7	14.0	12	6.0	6.0	19	1252820-06-06
315	10	3/8"	9/16"-18	1/2"-14	37.0	14.0	14	7.5	13.0	22	1252820-06-08
315	12	1/2"	3/4"-16	1/4"-19	36.0	17.0	12	9.0	5.0	19	1252820-08-04
315	12	1/2"	3/4"-16	3/8"-19	35.7	17.0	12	9.0	9.0	19	1252820-08-06
315	12	1/2"	3/4"-16	1/2"-14	39.7	17.0	14	9.5	9.5	22	1252820-08-08
315	12	1/2"	3/4"-16	3/4"-14	43.2	17.0	16	9.5	17.0	27	1252820-08-12
315	14, 15, 16	5/8"	7/8"-14	3/8"-19	38.7	19.5	12	12.0	9.0	24	1252820-10-06
315	14, 15, 16	5/8"	7/8"-14	1/2"-14	42.0	19.5	14	12.0	12.0	24	1252820-10-08
160	14, 15, 16	5/8"	7/8"-14	3/4"-14	44.2	19.5	16	12.0	18.0	27	1252820-10-12
315	18, 20	3/4"	1 1/16"-12	1/2"-14	46.2	22.0	14	15.0	13.5	27	1252820-12-08
160	18, 20	3/4"	1 1/16"-12	3/4"-14	48.3	22.0	16	15.0	15.0	27	1252820-12-12
160	18, 20	3/4"	1 1/16"-12	1"-11	50.5	22.0	18	15.0	21.0	36	1252820-12-16
160	25	1"	1 5/16"-12	1/2"-14	47.2	23.0	14	21.0	13.5	36	1252820-16-08
160	25	1"	1 5/16"-12	3/4"-14	49.0	23.0	16	21.0	18.0	36	1252820-16-12
160	25	1"	1 5/16"-12	1"-11	51.0	23.0	18	21.0	21.0	36	1252820-16-16
160	25	1"	1 5/16"-12	1 1/4"-11	53.0	23.0	20	21.0	32.0	46	1252820-16-20
160	25	1"	1 5/16"-12	1 1/2"-11	58.0	23.0	22	21.0	32.0	50	1252820-16-24
160	28, 30, 32	1 1/4"	1 5/8"-12	1"-11	55.0	24.3	18	26.5	21.0	46	1252820-20-16
160	28, 30, 32	1 1/4"	1 5/8"-12	1 1/4"-11	56.5	24.3	20	26.5	31.7	46	1252820-20-20
160	28, 30, 32	1 1/4"	1 5/8"-12	1 1/2"-11	60.8	24.3	22	26.5	38.0	50	1252820-20-24
140	35, 38	1 1/2"	1 7/8"-12	1 1/2"-11	64.0	27.5	22	32.0	32.0	50	1252820-24-24
140	35, 38	1 1/2"	1 7/8"-12	1 1/4"-11	60.0	27.5	20	31.7	31.7	50	1252820-24-20
140	50	2"	2 1/2"-12	2"-11	72.0	33.9	26	45.0	45.0	65	1252820-32-32

37° flare JIC swivel female to BSPP male

BOOK INDEX

SECTION INDEX

37° flare JIC fittings

to ISO 8434-2 / J514

BSP parallel thread has a Viton soft seal

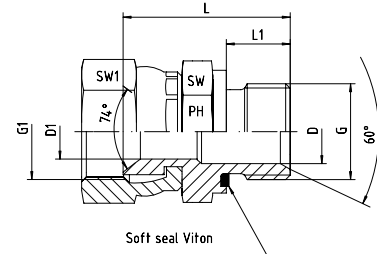

Pressure PN	Tube O.D.		Thread		Approx. Dimensions						Part code G1 x G	
	mm	in.	G1 = UNF/UN	G = BSP	L	L1	D	D1	SW1	SW		
350	6	1/4"	7/16"-20	1/8"-28	25.0	8	4.5	4.5	17	14	2052511-04-02	
350	6	1/4"	7/16"-20	1/4"-18	29.0	12	4.5	4.5	17	19	2052511-04-04	
350	6	1/4"	7/16"-20	3/8"-18	30.5	12	7.0	4.5	17	22	2052511-04-06	
350	8	5/16"	1/2"-20	1/8"-28	25.0	8	4.5	4.5	17	14	2052511-05-02	
350	8	5/16"	1/2"-20	1/4"-18	29.5	12	5.0	5.0	17	19	2052511-05-04	
350	8	5/16"	1/2"-20	3/8"-18	30.5	12	7.0	5.0	17	22	2052511-05-06	
350	10	3/8"	9/16"-18	1/8"-28	26.0	8	4.5	4.5	19	14	2052511-06-02	
350	10	3/8"	9/16"-18	1/4"-18	30.0	12	6.0	6.0	19	19	2052511-06-04	
350	10	3/8"	9/16"-18	3/8"-18	30.0	12	7.0	7.0	19	22	2052511-06-06	
350	10	3/8"	9/16"-18	1/2"-14	34.0	14	12.5	7.0	19	27	2052511-06-08	
350	12	1/2"	3/4"-16	1/4"-18	31.0	12	6.0	9.0	24	19	2052511-08-04	
350	12	1/2"	3/4"-16	3/8"-18	33.5	12	9.0	9.0	24	22	2052511-08-06	
350	12	1/2"	3/4"-16	1/2"-14	36.0	14	10.0	10.0	24	27	2052511-08-08	
350	12	1/2"	3/4"-16	3/4"-14	39.0	16	15.0	10.0	24	32	2052511-08-12	
350	14, 15, 16	5/8"	7/8"-14	3/8"-18	34.0	12	9.0	12.5	27	22	2052511-10-06	
350	14, 15, 16	5/8"	7/8"-14	1/2"-14	34.0	14	12.5	12.5	27	27	2052511-10-08	
350	14, 15, 16	5/8"	7/8"-14	5/8"-14	37.5	16	14.5	12.0	27	30	2052511-10-10	
350	14, 15, 16	5/8"	7/8"-14	3/4"-14	41.0	16	15.0	12.5	27	32	2052511-10-12	
350	18, 20	3/4"	1 1/16"-12	3/8"-18	34.0	12	9.0	9.0	32	27	2052511-12-06	
350	18, 20	3/4"	1 1/16"-12	1/2"-14	38.0	14	12.5	12.5	32	27	2052511-12-08	
350	18, 20	3/4"	1 1/16"-12	3/4"-14	40.0	16	15.0	15.0	32	32	2052511-12-12	
350	18, 20	3/4"	1 1/16"-12	1"-11	42.5	18	21.0	15.0	32	41	2052511-12-16	
280	25	1"	1 5/16"-12	1/2"-14	40.5	14	12.5	21.0	41	32	2052511-16-08	
280	25	1"	1 5/16"-12	3/4"-14	46.5	16	15.0	20.0	41	32	2052511-16-12	
280	25	1"	1 5/16"-12	1"-11	45.0	18	21.0	21.0	41	41	2052511-16-16	
210	25	1"	1 5/16"-12	1 1/4"-11	48.0	20	29.0	21.0	41	50	2052511-16-20	
210	28, 30, 32	1 1/4"	1 5/8"-12	1"-11	50.0	18	22.0	22.0	50	41	2052511-20-16	
210	28, 30, 32	1 1/4"	1 5/8"-12	1 1/4"-11	53.0	20	27.5	27.5	50	50	2052511-20-20	
210	35, 38	1 1/2"	1 7/8"-12	1 1/4"-11	55.0	20	29.0	29.0	55	50	2052511-24-20	
210	35, 38	1 1/2"	1 7/8"-12	1 1/2"-11	59.0	22	33.0	33.0	55	55	2052511-24-24	

37° flare JIC - Swivel female to male - form A

BOOK INDEX

SECTION INDEX

37° flare JIC fittings
to ISO 8434-2 / J514
Form A

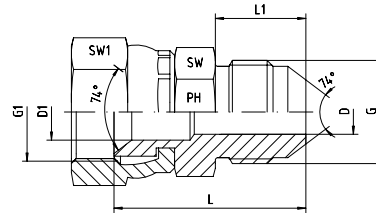

6

Pressure PN	Tube O.D.		Thread		Approx. Dimensions						Form	Part code G1 x G
	mm	in.	G1 = UNF/UN	G = UNF/UN	L	L1	D1	D	SW1	SW		
350	6	1/4"	7/16"-20	7/16"-20	29.0	14.0	4.0	4.0	17	12	A	2252511-04-04
350	6	1/4"	1/2"-20	7/16"-20	29.0	14.0	4.0	4.0	17	12	A	2252511-05-04
350	8	5/16"	1/2"-20	1/2"-20	30.0	14.0	5.0	5.0	17	14	A	2252511-05-05
350	10	3/8"	9/16"-18	9/16"-18	30.7	14.0	6.5	6.5	19	17	A	2252511-06-06
350	12	1/2"	9/16"-18	3/4"-16	34.5	17.0	7.0	9.5	19	22	A	2252511-06-08
350	12	1/2"	3/4"-16	3/4"-16	35.5	17.0	9.5	9.5	24	22	A	2252511-08-08
350	14, 15, 16	5/8"	3/4"-16	7/8"-14	39.4	19.5	10.0	12.0	24	24	A	2252511-08-10
350	12	1/2"	7/8"-14	3/4"-16	36.5	17.0	11.0	9.5	27	22	A	2252511-10-08
350	14, 15, 16	5/8"	7/8"-14	7/8"-14	40.5	19.5	12.0	12.0	27	24	A	2252511-10-10
350	18, 20	3/4"	7/8"-14	1 1/16"-12	45.5	22.0	12.0	15.0	27	27	A	2252511-10-12
350	14, 15, 16	5/8"	1 1/16"-12	7/8"-14	40.6	19.5	15.0	12.0	32	27	A	2252511-12-10
350	18, 20	3/4"	1 1/16"-12	1 1/16"-12	45.6	22.0	15.0	15.0	32	32	A	2252511-12-12
280	25	1"	1 5/16"-12	1 5/16"-12	48.7	23.0	21.0	21.0	41	36	A	2252511-16-16
210	28, 30, 32	1 1/2"	1 5/16"-12	1 5/8"-12	53.0	24.3	19.0	26.5	50	46	A	2252511-16-20
210	28, 30, 32	1 1/4"	1 5/8"-12	1 5/8"-12	56.0	24.3	27.5	27.5	50	46	A	2252511-20-20
210	35, 38	1 1/2"	1 7/8"-12	1 7/8"-12	60.0	27.5	33.0	33.0	55	50	A	2252511-24-24
	35, 38	1 1/2"	2 1/2"-12	1 7/8"-12	66.5	27.5	44.0	32.0	70	65	A	2252511-32-24

37° flare JIC – Swivel female to male - form B

BOOK INDEX

SECTION INDEX

37° flare JIC fittings
to ISO 8434-2 / J514
Form B

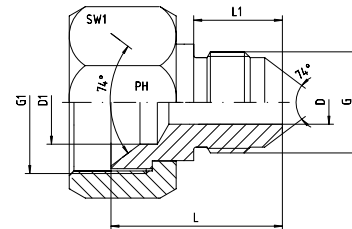
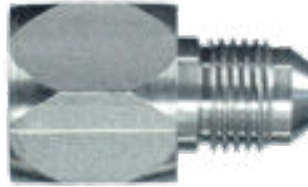

6

Pressure PN	Tube O.D.		Thread		Approx. Dimensions						Form	Part code G1 x G
	mm	in.	G1 = UNF/UN	G = UNF/UN	L	L1	D1	D	SW1	SW		
350	6	1/4"	9/16"-18	7/16"-20	26.0	14.0	7.0	4.0	19		B	2252511-06-04
350	6	1/4"	3/4"-16	7/16"-20	26.0	14.0	9.0	4.0	22		B	2252511-08-04
350	8	5/16"	3/4"-16	1/2"-20	26.0	14.0	9.0	6.0	22		B	2252511-08-05
350	10	3/8"	3/4"-16	9/16"-18	26.0	14.0	9.0	7.5	22		B	2252511-08-06
350	6	1/4"	7/8"-14	7/16"-20	28.0	14.0	11.0	4.5	27		B	2252511-10-04
350	10	3/8"	7/8"-14	9/16"-18	28.0	14.0	11.0	7.5	27		B	2252511-10-06
350	6	1/4"	1 1/16"-12	7/16"-20	28.5	14.0	15.0	4.0	32		B	2252511-12-04
350	10	3/8"	1 1/16"-12	9/16"-18	30.4	14.0	15.0	7.5	32		B	2252511-12-06
350	12	1/2"	1 1/16"-12	3/4"-16	33.0	17.0	15.0	9.5	32		B	2252511-12-08
280	6	1/4"	1 5/16"-12	7/16"-20	31.0	14.0	19.0	4.0	41		B	2252511-16-04
280	10	3/8"	1 5/16"-12	9/16"-18	32.0	14.0	19.0	7.5	41		B	2252511-16-06
280	12	1/2"	1 5/16"-12	3/4"-16	35.0	17.0	19.0	9.5	41		B	2252511-16-08
280	14, 15, 16	5/8"	1 5/16"-12	7/8"-14	37.0	19.5	19.0	12.0	41		B	2252511-16-10
280	18, 20	3/4"	1 5/16"-12	1 1/16"-12	40.0	22.0	19.0	15.5	41		B	2252511-16-12
210	12	1/2"	1 5/8"-12	3/4"-16	35.0	16.7	26.0	9.5	50		B	2252511-20-08
210	14, 15, 16	5/8"	1 5/8"-12	7/8"-14	37.3	19.5	26.0	12.0	50		B	2252511-20-10
210	18, 20	3/4"	1 5/8"-12	1 1/16"-12	40.0	22.0	26.0	15.0	50		B	2252511-20-12
210	25	1"	1 5/8"-12	1 5/16"-12	41.0	23.0	26.0	21.0	50		B	2252511-20-16
210	14, 15, 16	5/8"	1 7/8"-12	7/8"-14	41.0	19.3	30.0	12.0	60		B	2252511-24-10
210	25	1"	1 7/8"-12	1 5/16"-12	45.0	23.0	30.0	21.0	60		B	2252511-24-16
210	28, 30, 32	1 1/4"	1 7/8"-12	1 5/8"-12	62.0	24.3	32.0	26.5	60		B	2252511-24-20

37° flare JIC – Male plug

BOOK INDEX

SECTION INDEX

37° flare JIC fittings
to ISO 8434-2 / J514

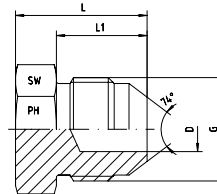

6

Pressure PN	Tube O.D.		Thread G	Approx. Dimensions				Part code
	mm	in.		L	L1	D	SW	
350	6	1/4"	7/16"-20 UNF	20.5	14.0	4.0	12	5250010-04
350	8	5/16"	1/2"-20 UNF	20.5	14.0	5.0	14	5250010-05
350	10	3/8"	9/16"-18 UNF	22.0	14.0	7.0	17	5250010-06
350	12	1/2"	3/4"-16 UNF	24.0	17.0	9.5	22	5250010-08
350	14, 15, 16	5/8"	7/8"-14 UNF	28.0	19.5	12.0	24	5250010-10
350	18, 20	3/4"	1 1/16"-12 UN	33.0	22.0	15.0	27	5250010-12
280	25	1"	1 5/16"-12 UN	34.0	23.0	21.5	36	5250010-16
210	28, 30, 32	1 1/4"	1 5/8"-12 UN	37.7	24.3	27.5	46	5250010-20
210	35, 38	1 1/2"	1 7/8"-12 UN	42.5	27.5	33.0	50	5250010-24
150	50	2"	2 1/2"-12 UN	52.0	33.9	45.0	65	5250010-32

37° flare JIC – Swivel female cap

BOOK INDEX

SECTION INDEX

37° flare JIC fittings
to ISO 8434-2 / J514

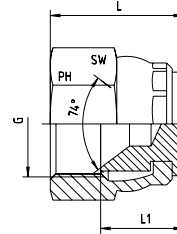

Pressure PN	Tube O.D.		Thread G	Approx. Dimensions			Part code
	mm	in.		L	L1	SW	
350	6	1/4"	7/16"-20 UNF	20.0	12	17	5250011-04
350	8	5/16"	1/2"-20 UNF	22.0	12	17	5250011-05
350	10	3/8"	9/16"-18 UNF	23.0	13	19	5250011-06
350	12	1/2"	3/4"-16 UNF	25.5	14	24	5250011-08
350	14, 15, 16	5/8"	7/8"-14 UNF	30.0	18	27	5250011-10
350	18, 20	3/4"	1 1/16"-12 UN	33.0	18	32	5250011-12
280	25	1"	1 5/16"-12 UN	36.0	21	41	5250011-16
210	28, 30, 32	1 1/4"	1 5/8"-12 UN	39.5	22	50	5250011-20
210	35, 38	1 1/2"	1 7/8"-12 UN	44.0	24	55	5250011-24
	50	2"	2 1/2"-12 UN	56.0	32	70	5250011-32

37° flare JIC male to NPT male 90° elbow

BOOK INDEX
SECTION INDEX

37° flare JIC fittings
to ISO 8434-2 / J514

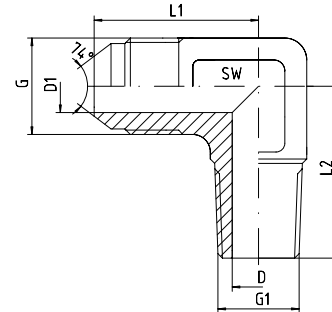

Pressure PN	Tube O.D.		Thread		Approx. Dimensions					Part code G x G1
	mm	in.	G = UNF/UN	G1 = NPT	L1	L2	D	D1	SW	
350	6	1/4"	7/16"-20	1/8"-27	23.0	20.0	4.5	4.0	11	1252517-04-02
350	6	1/4"	7/16"-20	1/4"-18	28.5	26.5	4.5	4.5	14	1252517-04-04
350	6	1/4"	7/16"-20	3/8"-18	29.0	31.0	10.0	4.0	19	1252517-04-06
350	8	5/16"	1/2"-20	1/8"-27	24.0	20.0	4.5	6.0	13	1252517-05-02
350	8	5/16"	1/2"-20	1/4"-18	27.0	28.0	7.0	6.0	14	1252517-05-04
350	8	5/16"	1/2"-20	3/8"-18	29.0	31.0	10.0	6.0	19	1252517-05-06
350	10	3/8"	9/16"-18	1/8"-27	27.0	25.0	4.0	7.5	14	1252517-06-02
350	10	3/8"	9/16"-18	1/4"-18	27.0	25.0	7.5	7.5	14	1252517-06-04
350	10	3/8"	9/16"-18	3/8"-18	27.0	27.0	8.5	7.5	14	1252517-06-06
350	10	3/8"	9/16"-18	1/2"-14	31.0	36.0	13.0	7.5	19	1252517-06-08
350	12	1/2"	3/4"-16	1/4"-18	31.0	29.5	7.0	10.0	19	1252517-08-04
350	12	1/2"	3/4"-16	3/8"-18	31.0	29.5	10.0	10.0	19	1252517-08-06
350	12	1/2"	3/4"-16	1/2"-14	31.0	34.0	10.0	10.0	19	1252517-08-08
350	12	1/2"	3/4"-16	3/4"-14	37.0	41.5	15.5	10.0	24	1252517-08-12
350	14, 15, 16	5/8"	7/8"-14	3/8"-18	37.5	37.0	10.0	12.5	24	1252517-10-06
350	14, 15, 16	5/8"	7/8"-14	1/2"-14	37.5	38.0	14.0	12.5	24	1252517-10-08
280	14, 15, 16	5/8"	7/8"-14	3/4"-14	37.5	41.5	15.5	12.5	24	1252517-10-12
350	18, 20	3/4"	1 1/16"-12	1/2"-14	42.0	38.0	14.0	15.5	24	1252517-12-08
280	18, 20	3/4"	1 1/16"-12	3/4"-14	42.0	41.5	15.5	15.5	24	1252517-12-12
210	18, 20	3/4"	1 1/16"-12	1"-11.5	45.0	50.0	24.0	16.0	33	1252517-12-16
280	25	1"	1 5/16"-12	1/2"-14					33	1252517-16-08
280	25	1"	1 5/16"-12	3/4"-14	46.0	45.0	18.0	22.0	33	1252517-16-12
210	25	1"	1 5/16"-12	1"-11.5	49.0	50.0	21.0	22.0	33	1252517-16-16
210	28, 30, 32	1 1/4"	1 5/8"-12	1"-11.5	52.0	60.0	24.0	28.0	41	1252517-20-16
170	28, 30, 32	1 1/4"	1 5/8"-12	1 1/4"-11.5	52.0	61.0	32.0	28.0	45	1252517-20-20
140	35, 38	1 1/2"	1 7/8"-12	1 1/4"-11.5	59.0	57.0	32.0	33.0	48	1252517-24-20
140	35, 38	1 1/2"	1 7/8"-12	1 1/2"-11.5	64.0	59.0	33.0	33.0	50	1252517-24-24
140	50	2"	2 1/2"-12	2"-11.5	77.5	76.0	45.0	45.0	65	1252517-32-32

37° flare JIC male to BSP taper male 90° elbow

BOOK INDEX

SECTION INDEX

37° flare JIC fittings
to ISO 8434-2 / J514

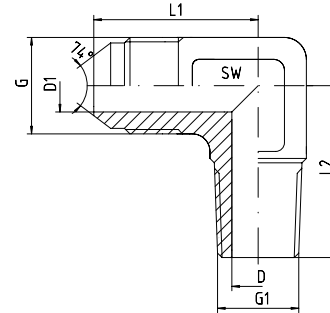

Pressure PN	Tube O.D.		Thread		Approx. Dimensions					Part code G x G1
	mm	in.	G = UNF/UN	G1 = keg.	L1	L2	D	D1	SW	
315	6	1/4"	7/16"-20	1/8"-28	23.0	20.0	5.0	4.0	12	1252520-04-02
315	6	1/4"	7/16"-20	1/4"-19	27.0	28.0	7.0	4.0	14	1252520-04-04
315	6	1/4"	7/16"-20	3/8"-19	27.0	30.0	10.0	4.0	19	1252520-04-06
315	8	5/16"	1/2"-20	1/8"-28	24.0	20.0	5.0	6.0	13	1252520-05-02
315	8	5/16"	1/2"-20	1/4"-19	27.0	28.0	7.0	6.0	14	1252520-05-04
315	8	5/16"	1/2"-20	3/8"-19	28.0	30.0	10.0	6.0	19	1252520-05-06
315	10	3/8"	9/16"-18	1/8"-28						1252520-06-02
315	10	3/8"	9/16"-18	1/4"-19	27.0	28.0	7.0	8.0	14	1252520-06-04
315	10	3/8"	9/16"-18	3/8"-19	29.0	31.0	10.0	8.0	19	1252520-06-06
315	10	3/8"	9/16"-18	1/2"-14	31.0	36.0	13.0	7.5	19	1252520-06-08
315	12	1/2"	3/4"-16	1/4"-19	32.0	31.0	7.0	10.0	19	1252520-08-04
315	12	1/2"	3/4"-16	3/8"-19	32.0	31.0	10.0	10.0	19	1252520-08-06
315	12	1/2"	3/4"-16	1/2"-14	34.0	37.0	14.0	10.0	22	1252520-08-08
315	14, 15, 16	5/8"	7/8"-14	3/8"-19	37.0	33.0	10.0	12.0	22	1252520-10-06
315	14, 15, 16	5/8"	7/8"-14	1/2"-14	37.0	37.0	14.0	12.0	22	1252520-10-08
160	14, 15, 16	5/8"	7/8"-14	3/4"-14	39.0	40.0	18.0	12.0	27	1252520-10-12
315	18, 20	3/4"	1 1/16"-12	1/2"-14	42.0	40.0	14.0	16.0	27	1252520-12-08
160	18, 20	3/4"	1 1/16"-12	3/4"-14	42.0	40.0	18.0	16.0	27	1252520-12-12
160	18, 20	3/4"	1 1/16"-12	1"-11	45.0	50.0	24.0	16.0	33	1252520-12-16
160	25	1"	1 5/16"-12	1/2"-14						1252520-16-08
160	25	1"	1 5/16"-12	3/4"-14	46.0	45.0	18.0	22.0	33	1252520-16-12
160	25	1"	1 5/16"-12	1"-11	46.0	50.0	24.0	22.0	33	1252520-16-16
160	28, 30, 32	1 1/4"	1 5/8"-12	1"-11	52.0	60.0	24.0	28.0	41	1252520-20-16
160	28, 30, 32	1 1/4"	1 5/8"-12	1 1/4"-11	52.0	61.0	32.0	28.0	41	1252520-20-20
140	35, 38	1 1/2"	1 7/8"-12	1 1/4"-11						1252520-24-20
140	35, 38	1 1/2"	1 7/8"-12	1 1/2"-11	64.0	59.0	33.0	33.0	50	1252520-24-24

37° flare JIC – Straight bulkhead

BOOK INDEX

SECTION INDEX

37° flare JIC fittings
to ISO 8434-2 / J514
Supplied with locknut

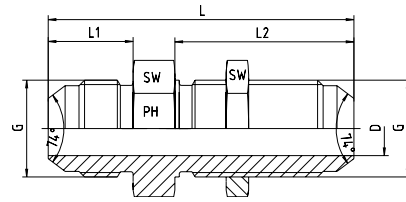

Pressure PN	Tube O.D.		Thread G	Approx. Dimensions					Part code	
	mm	in.		L	L1	L2	D	SW		
350	6	1/4"	7/16"-20 UNF	52.5	14.0	31.5	4.0	17		1252513-04-04
350	8	5/16"	1/2"-20 UNF	52.5	14.0	31.5	6.0	19		1252513-05-05
350	10	3/8"	9/16"-18 UNF	55.5	14.0	33.0	7.5	22		1252513-06-06
350	12	1/2"	3/4"-16 UNF	62.0	16.5	37.0	10.0	24		1252513-08-08
350	14, 15, 16	5/8"	7/8"-14 UNF	69.5	19.0	40.5	12.0	30		1252513-10-10
350	18, 20	3/4"	1 1/16"-12 UN	78.5	21.5	45.0	15.5	36		1252513-12-12
280	25	1"	1 5/16"-12 UN	80.0	23.1	44.4	21.5	41		1252513-16-16
210	28, 30, 32	1 1/4"	1 5/8"-12 UN	84.0	24.3	45.7	27.5	50		1252513-20-20
210	35, 38	1 1/2"	1 7/8"-12 UN	89.5	27.5	46.0	33.0	55		1252513-24-24
150	50	2"	2 1/2"-12 UN	106.5	33.9	53.0	45.0	70		1252513-32-32

37° flare JIC – 90° bulkhead elbow

BOOK INDEX

SECTION INDEX

37° flare JIC fittings
to ISO 8434-2 / J514
Supplied with locknut

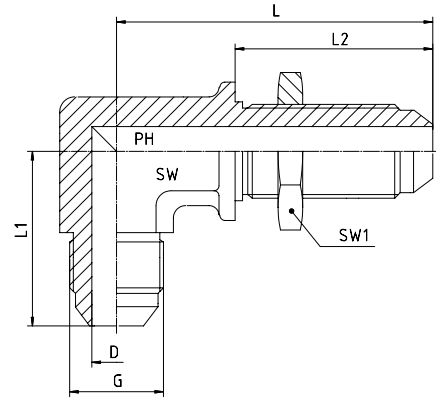

Pressure PN	Tube O.D.		Thread G	Approx. Dimensions						Part code
	mm	in.		L	L1	L2	D	SW	SW1	
350	6	1/4"	7/16"-20 UNF	40	25	26	4.0	11	17	1252521-04-04
350	8	5/16"	1/2"-20 UNF	44	27	26	6.0	13	19	1252521-05-05
350	10	3/8"	9/16"-18 UNF	46	28	28	8.0	14	22	1252521-06-06
350	12	1/2"	3/4"-16 UNF	54	36	32	10.0	19	24	1252521-08-08
350	14, 15, 16	5/8"	7/8"-14 UNF	61	40	35	12.0	22	30	1252521-10-10
350	18, 20	3/4"	1 1/16"-12 UN	68	45	40	16.0	27	36	1252521-12-12
280	25	1"	1 5/16"-12 UN	71	49	40	22.0	41	41	1252521-16-16
210	28, 30, 32	1 1/4"	1 5/8"-12 UN	80	55	41	28.0	41	50	1252521-20-20
210	35, 38	1 1/2"	1 7/8"-12 UN							1252521-24-24

SAE UNF locknut

BOOK INDEX

SECTION INDEX

SAE UNF locknut

for 37° flare JIC bulkhead fittings
to ISO 8434-2 / J514

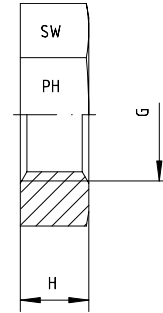

Thread G = UNF/UN	H	SW	Part code
7/16" -20 UNF	6.4	17	1252523-04
1/2" -20 UNF	6.4	19	1252523-05
9/16" -18 UNF	6.9	22	1252523-06
3/4" -16 UNF	7.9	24	1252523-08
7/8" -14 UNF	9.1	30	1252523-10
1 1/16" -12 UN	10.4	36	1252523-12
1 5/16" -12 UN	10.4	41	1252523-16
1 5/8" -12 UN	10.4	50	1252523-20
1 7/8" -12 UN	10.4	55	1252523-24
2 1/2" -12 UN	10.4	70	1252523-32

37° flare JIC swivel female to NPT male

BOOK INDEX

SECTION INDEX

37° flare JIC fittings
to ISO 8434-2 / J514

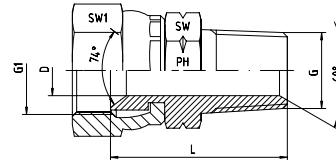

6

Pressure PN	Tube O.D.		Thread		Approx. Dimensions				Part code G1 x G
	mm	in.	G1 = UNF/UN	G = NPT	L	D	SW1	SW	
350	6	1/4"	7/16"-20	1/8"-27	24.0	4.0	17	12	1252518-04-02
350	6	1/4"	7/16"-20	1/4"-18	30.0	4.0	17	17	1252518-04-04
350	6	1/4"	7/16"-20	3/8"-18	30.0	4.0	17	19	1252518-04-06
350	8	5/16"	1/2"-20	1/8"-27	24.0	4.0	17	12	1252518-05-02
350	8	5/16"	1/2"-20	1/4"-18	30.0	4.0	17	14	1252518-05-04
350	8	5/16"	1/2"-20	3/8"-18	31.0	4.0	17	19	1252518-05-06
350	10	3/8"	9/16"-18	1/8"-27	24.5	4.0	19	14	1252518-06-02
350	10	3/8"	9/16"-18	1/4"-18	30.0	6.0	19	17	1252518-06-04
350	10	3/8"	9/16"-18	3/8"-18	31.5	7.0	19	19	1252518-06-06
350	10	3/8"	9/16"-18	1/2"-14	36.0	7.0	19	22	1252518-06-08
350	12	1/2"	3/4"-16	1/4"-18	32.0	6.0	24	17	1252518-08-04
350	12	1/2"	3/4"-16	3/8"-18	32.5	9.0	24	19	1252518-08-06
350	12	1/2"	3/4"-16	1/2"-14	39.0	9.0	24	22	1252518-08-08
280	12	1/2"	3/4"-16	3/4"-14	40.0	10.0	24	27	1252518-08-12
350	14, 15, 16	5/8"	7/8"-14	3/8"-18	35.0	9.0	27	22	1252518-10-06
350	14, 15, 16	5/8"	7/8"-14	1/2"-14	40.0	12.0	27	22	1252518-10-08
280	14, 15, 16	5/8"	7/8"-14	3/4"-14	41.0	12.5	27	27	1252518-10-12
280	18, 20	3/4"	1 1/16"-12	1/2"-14	41.0	13.5	32	27	1252518-12-08
280	18, 20	3/4"	1 1/16"-12	3/4"-14	41.0	15.0	32	27	1252518-12-12
280	18, 20	3/4"	1 1/16"-12	1"-11.5	46.0	15.0	32	36	1252518-12-16
280	25	1"	1 5/16"-12	1/2"-14					1252518-16-08
280	25	1"	1 5/16"-12	3/4"-14	45.0	18.0	41	32	1252518-16-12
280	25	1"	1 5/16"-12	1"-11.5	48.0	21.0	41	36	1252518-16-16
210	25	1"	1 5/16"-12	1 1/4"-11.5	52.0	21.0	41	46	1252518-16-20
210	28, 30, 32	1 1/4"	1 5/8"-12	1"-11.5	48.5	21.0	50	41	1252518-20-16
210	28, 30, 32	1 1/4"	1 5/8"-12	1 1/4"-11.5	52.0	27.5	50	46	1252518-20-20
210	28, 30, 32	1 1/4"	1 5/8"-12	1 1/2"-11.5			50		1252518-20-24
210	35, 38	1 1/2"	1 7/8"-12	1 1/4"-11.5	54.0	32.0	55	46	1252518-24-20
210	35, 38	1 1/2"	1 7/8"-12	1 1/2"-11.5	54.5	33.0	55	50	1252518-24-24

37° flare JIC swivel female to NPT male 90° elbow

BOOK INDEX

SECTION INDEX

37° flare JIC fittings
to ISO 8434-2 / J514

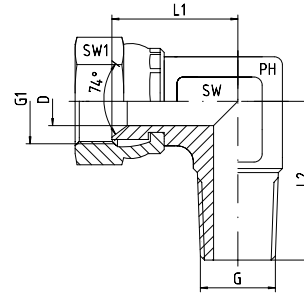

Pressure PN	Tube O.D.		Thread		Approx. Dimensions					Part code G1 x G
	mm	in.	G1 = UNF/UN	G = NPT	L1	L2	D	SW	SW1	
350	6	1/4"	7/16"-20	1/8"-27	18.5	20.0	4.5	12	17	1252519-04-02
350	6	1/4"	7/16"-20	1/4"-18	18.5	25.0	4.5	14	17	1252519-04-04
350	6	1/4"	7/16"-20	3/8"-18					17	1252519-04-06
350	8	5/16"	1/2"-20	1/8"-27					17	1252519-05-02
350	8	5/16"	1/2"-20	1/4"-18	18.5	25.0	6.0	14	17	1252519-05-04
350	8	5/16"	1/2"-20	3/8"-18					17	1252519-05-06
350	10	3/8"	9/16"-18	1/4"-18	22.3	25.0	7.5	14	19	1252519-06-04
350	10	3/8"	9/16"-18	3/8"-18	22.3	27.0	7.5	14	19	1252519-06-06
350	10	3/8"	9/16"-18	1/2"-14					19	1252519-06-08
350	12	1/2"	3/4"-16	1/4"-18	24.5	29.5	10.0	19	24	1252519-08-04
350	12	1/2"	3/4"-16	3/8"-18	24.5	29.5	10.0	19	24	1252519-08-06
350	12	1/2"	3/4"-16	1/2"-14	24.5	34.0	10.0		24	1252519-08-08
280	12	1/2"	3/4"-16	3/4"-14					24	1252519-08-12
350	14, 15, 16	5/8"	7/8"-14	3/8"-18	29.5	37.0	12.0	24	27	1252519-10-06
350	14, 15, 16	5/8"	7/8"-14	1/2"-14	29.5	38.0	12.0	24	27	1252519-10-08
280	14, 15, 16	5/8"	7/8"-14	3/4"-14	29.5	41.5	12.0	24	27	1252519-10-12
280	18, 20	3/4"	1 1/16"-12	1/2"-14	31.0	38.0	15.5	24	32	1252519-12-08
280	18, 20	3/4"	1 1/16"-12	3/4"-14	31.0	41.5	15.5	24	32	1252519-12-12
280	18, 20	3/4"	1 1/16"-12	1"-11.5					32	1252519-12-16
280	25	1"	1 5/16"-12	3/4"-14	37.0	46.0	21.0	33	41	1252519-16-12
280	25	1"	1 5/16"-12	1"-11.5				33	41	1252519-16-16
210	25	1"	1 5/16"-12	1 1/4"-11.5					41	1252519-16-20
210	28, 30, 32	1 1/4"	1 5/8"-12	1"-11.5					50	1252519-20-16
210	28, 30, 32	1 1/4"	1 5/8"-12	1 1/4"-11.5					50	1252519-20-20
210	28, 30, 32	1 1/4"	1 5/8"-12	1 1/2"-11.5					50	1252519-20-24
210	35, 38	1 1/2"	1 7/8"-12	1 1/4"-11.5					55	1252519-24-20
210	35, 38	1 1/2"	1 7/8"-12	1 1/2"-11.5	47.2	63.0	33.0	50	55	1252519-24-24

37° flare JIC swivel female to male 90° elbow

BOOK INDEX

SECTION INDEX

37° flare JIC fittings
to ISO 8434-2 / J514

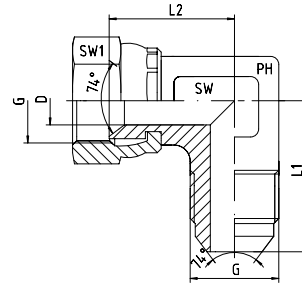

Pressure PN	Tube O.D.		Thread G = UNF/UN	Approx. Dimensions					Part code
	mm	in.		L1	L2	D	SW	SW1	
350	6	1/4"	7/16"-20	22.5	16.7	4.0	12	16	1252514-04-04
350	8	5/16"	1/2"-20	24.0	17.5	5.5	13	17	1252514-05-05
350	10	3/8"	9/16"-18	27.0	22.5	7.5	14	19	1252514-06-06
350	12	1/2"	3/4"-16	32.0	24.5	10.0	19	24	1252514-08-08
350	14, 15, 16	5/8"	7/8"-14	37.5	29.5	12.0	24	27	1252514-10-10
350	18, 20	3/4"	1 1/16"-12	42.0	31.0	15.5	24	32	1252514-12-12
250	25	1"	1 5/16"-12	46.0	35.7	21.5	33	41	1252514-16-16
210	28, 30, 32	1 1/4"	1 5/8"-12	52.5	42.8	27.5	41	50	1252514-20-20
140	35, 38	1 1/2"	1 7/8"-12	59.0	47.2	33.0	50	55	1252514-24-24
150	50	2"	2 1/2"-12	77.5	62.1	45.0	65	70	1252514-32-32

37° flare JIC swivel female to male 45° elbow

BOOK INDEX

SECTION INDEX

37° flare JIC fittings
to ISO 8434-2 / J514

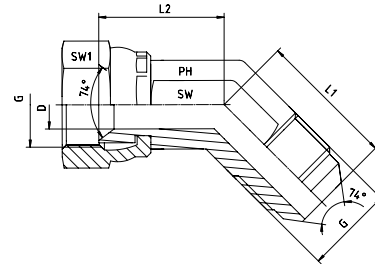

Pressure PN	Tube O.D.		Thread G = UNF/UN	Approx. Dimensions					Part code
	mm	in.		L1	L2	D	SW	SW1	
350	6	1/4"	7/16"-20	18.0	15.0	4.0	12	14	1252522-04-04
350	8	5/16"	1/2"-20	20.0	16.0	5.5	14	17	1252522-05-05
350	10	3/8"	9/16"-18	21.0	19.0	7.5	14	19	1252522-06-06
350	12	1/2"	3/4"-16	25.0	22.0	10.0	19	24	1252522-08-08
350	14, 15, 16	5/8"	7/8"-14	28.0	24.0	12.0	24	27	1252522-10-10
350	18, 20	3/4"	1 1/16"-12	33.0	24.0	15.5	24	32	1252522-12-12
250	25	1"	1 5/16"-12	37.0	29.0	21.5	33	41	1252522-16-16
210	28, 30, 32	1 1/4"	1 5/8"-12	40.0	36.0	27.5	41	50	1252522-20-20
140	35, 38	1 1/2"	1 7/8"-12	45.0	39.0	33.0	48	60	1252522-24-24
150	50	2"	2 1/2"-12	56.5	50.1	45.0	65	70	1252522-32-32

37° flare JIC - Swivel female branch tee

BOOK INDEX

SECTION INDEX

37° flare JIC fittings
to ISO 8434-2 / J514

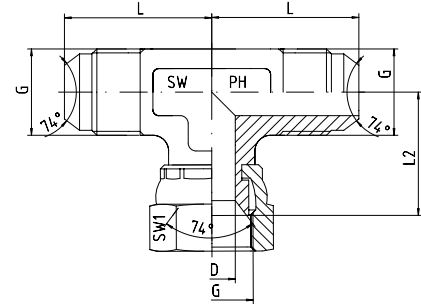

6

Pressure PN	Tube O.D.		Thread G	Approx. Dimensions					Part code
	mm	in.		L	L2	D	SW	SW1	
350	6	1/4"	7/16"-20 UNF	22.5	16.7	4.0	12	14	1252515-04-04-04
350	8	5/16"	1/2"-20 UNF	24.0	17.5	5.5	13	17	1252515-05-05-05
350	10	3/8"	9/16"-18 UNF	27.0	22.3	7.5	14	19	1252515-06-06-06
350	12	1/2"	3/4"-16 UNF	31.0	24.5	10.0	19	24	1252515-08-08-08
350	14, 15, 16	5/8"	7/8"-14 UNF	37.5	29.5	12.0	24	27	1252515-10-10-10
350	18, 20	3/4"	1 1/16"-12 UN	42.0	31.0	15.5	24	32	1252515-12-12-12
250	25	1"	1 5/16"-12 UN	46.0	35.7	21.5	33	41	1252515-16-16-16
210	28, 30, 32	1 1/4"	1 5/8"-12 UN	52.5	42.8	27.5	41	50	1252515-20-20-20
170	35, 38	1 1/2"	1 7/8"-12 UN	59.0	47.2	33.0	50	60	1252515-24-24-24
150	50	2"	2 1/2"-12 UN	77.5	62.1	45.0	65	70	1252515-32-32-32

37° flare JIC - Swivel female run tee

BOOK INDEX

SECTION INDEX

37° flare JIC fittings
to ISO 8434-2 / J514

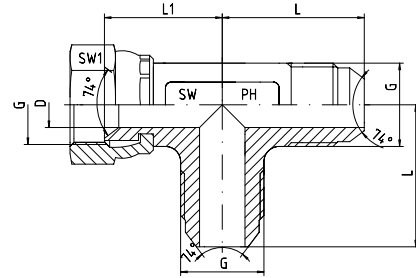

6

Pressure PN	Tube O.D.		Thread G	Approx. Dimensions					Part code
	mm	in.		L	L1	D	SW	SW1	
350	6	1/4"	7/16"-20 UNF	22.5	16.7	4.0	12	14	1252516-04-04-04
350	8	5/16"	1/2"-20 UNF	24.0	17.5	5.5	13	17	1252516-05-05-05
350	10	3/8"	9/16"-18 UNF	27.0	22.3	7.5	14	19	1252516-06-06-06
350	12	1/2"	3/4"-16 UNF	31.0	24.5	10.0	19	24	1252516-08-08-08
350	14, 15, 16	5/8"	7/8"-14 UNF	37.5	29.5	12.0	24	27	1252516-10-10-10
350	18, 20	3/4"	1 1/16"-12 UN	42.0	31.0	15.5	24	32	1252516-12-12-12
250	25	1"	1 5/16"-12 UN	46.0	35.7	21.5	33	41	1252516-16-16-16
210	28, 30, 32	1 1/4"	1 5/8"-12 UN	52.5	42.8	27.5	41	50	1252516-20-20-20
170	35, 38	1 1/2"	1 7/8"-12 UN	59.9	47.2	33.0	50	60	1252516-24-24-24
150	50	2"	2 1/2"-12 UN	77.5	62.1	45.0	65	70	1252516-32-32-32

37° flare JIC male to positionable BSPP male 90° elbow

BOOK INDEX

SECTION INDEX

37° flare JIC fittings

to ISO 8434-2 / J514

BSP parallel positionable male thread with O-ring and sealing washer

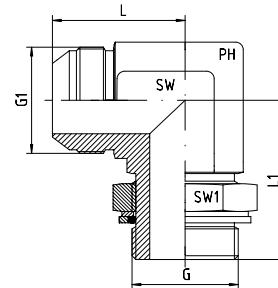

Pressure PN	Tube O.D.		Thread		Approx. Dimensions				Part code G1 x G
	mm	in.	G1 = UNF/UN	G = BSP	L	L1	SW	SW1	
250	6	1/4"	7/16"-20	1/8"	22.6	26.5	11	14	1252530-04-02
200	6	1/4"	7/16"-20	1/4"	22.6	32.0	14	19	1252530-04-04
200	8	5/16"	1/2"-20	1/4"	26.6	32.0	14	19	1252530-05-04
200	10	3/8"	9/16"-18	1/4"	26.9	32.0	14	19	1252530-06-04
200	10	3/8"	9/16"-18	3/8"	29.0	37.0	19	22	1252530-06-06
200	10	3/8"	9/16"-18	1/2"	31.0	43.0	22	27	1252530-06-08
200	12	1/2"	3/4"-16	3/8"	31.8	37.0	19	22	1252530-08-06
200	12	1/2"	3/4"-16	1/2"	33.8	43.0	22	27	1252530-08-08
200	14, 15, 16	5/8"	7/8"-14	1/2"	36.8	43.0	22	27	1252530-10-08
200	18, 20	3/4"	1 1/16"-12	1/2"	42.2	49.5	27	27	1252530-12-08
200	18, 20	3/4"	1 1/16"-12	3/4"	42.2	49.5	27	36	1252530-12-12
200	25	1"	1 5/16"-12	1"	46.0	52.0	33	41	1252530-16-16
160	28, 30, 32	1 1/4"	1 5/8"-12	1 1/4"	52.3	57.0	41	50	1252530-20-20
140	35, 38	1 1/2"	1 7/8"-12	1 1/2"	59.2	61.0	50	55	1252530-24-24

37° flare JIC male to positionable SAE UNF male 90° elbow

BOOK INDEX

SECTION INDEX

37° flare JIC fittings

to ISO 8434-2 / J514

SAE UNF parallel positionable male thread with O-ring and sealing washer

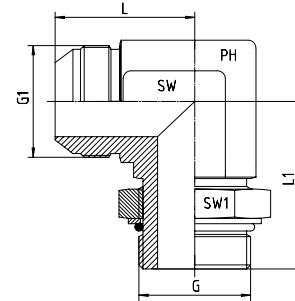

Pressure PN	Tube O.D.		Thread		Approx. Dimensions				Part code G1 x G
	mm	in.	G1 = UNF/UN	G = UN/UNF	L	L1	SW	SW1	
350	6	1/4"	7/16"-20	7/16"-20	23	26	11	14	1252533-04-04
350	8	5/16"	1/2"-20	1/2"-20	24	29	13	16	1252533-05-05
350	10	3/8"	9/16"-18	9/16"-18	27	32	14	17	1252533-06-06
350	12	1/2"	3/4"-16	3/4"-16	32	37	19	22	1252533-08-08
350	14, 15, 16	5/8"	7/8"-14	7/8"-14	37	43	22	27	1252533-10-10
350	18, 20	3/4"	1 1/16"-12	1 1/16"-12	42	49	27	32	1252533-12-12
280	25	1"	1 5/16"-12	1 5/16"-12	46	52	33	38	1252533-16-16
210	28, 30, 32	1 1/4"	1 5/8"-12	1 5/8"-12	52	57	41	50	1252533-20-20
140	35, 38	1 1/2"	1 7/8"-12	1 7/8"-12	59	61	50	55	1252533-24-24

37° flare JIC fittings

to ISO 8434-2 / J514

BSP parallel positionable male thread with O-ring and sealing washer

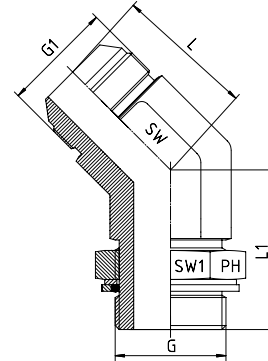

Pressure PN	Tube O.D.		Thread		Approx. Dimensions				Part code G1 x G
	mm	in.	G1 = UNF/UN	G = BSP	L	L1	SW	SW1	
250	6	1/4"	7/16"-20	1/8"	18	27	11	14	1252534-04-02
200	6	1/4"	7/16"-20	1/4"	21	29	14	19	1252534-04-04
200	8	5/16"	1/2"-20	1/8"	20	27	14	14	1252534-05-02
200	8	5/16"	1/2"-20	1/4"	21	27	14	19	1252534-05-04
200	10	3/8"	9/16"-18	1/4"	21	29	14	19	1252534-06-04
200	10	3/8"	9/16"-18	3/8"	22	33	19	22	1252534-06-06
200	10	3/8"	9/16"-18	1/2"	22	39	22	27	1252534-06-08
200	12	1/2"	3/4"-16	3/8"	25	33	19	22	1252534-08-06
200	12	1/2"	3/4"-16	1/2"	25	39	22	27	1252534-08-08
200	14, 15, 16	5/8"	7/8"-14	1/2"	28	39	22	27	1252534-10-08
200	18, 20	3/4"	1 1/16"-12	3/4"	33	44	27	36	1252534-12-12

37° flare JIC male to BSPP female pressure gauge connector

BOOK INDEX

SECTION INDEX

37° flare JIC fittings

to ISO 8434-2 / J514

BSP parallel female thread -
with metallic sealing ring

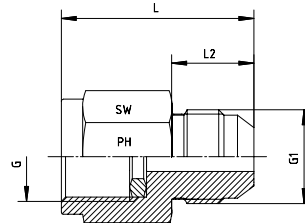

Pressure PN	Tube O.D.		Thread		Approx. Dimensions			Part code G1 x G
	mm	in.	G1 = UNF	G = BSP	L	L2	SW	
350	6	1/4"	7/16"-20	1/4"-19	33	14	17	1252531-04-04
350	6	1/4"	7/16"-20	1/2"-14	40	14	27	1252531-04-08
350	8	5/16"	1/2"-20	1/4"-19	33	14	17	1252531-05-04
350	8	5/16"	1/2"-20	1/2"-14	40	14	27	1252531-05-08
350	10	3/8"	9/16"-18	1/4"-19	30	14	17	1252531-06-04
350	10	3/8"	9/16"-18	1/2"-14	40	14	27	1252531-06-08
350	12	1/2"	3/4"-16	1/4"-19	31	17	22	1252531-08-04
350	12	1/2"	3/4"-16	1/2"-14	44	17	27	1252531-08-08

6

37° flare JIC male to BSPP female

BOOK INDEX

SECTION INDEX

37° flare JIC fittings
to ISO 8434-2 / J514

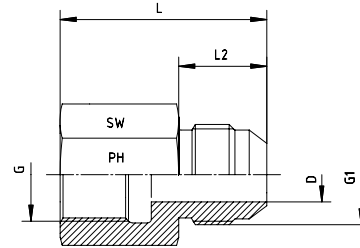

Pressure PN	Tube O.D.		Thread		Approx. Dimensions				Part code G1 x G
	mm	in.	G1 = UNF/UN	G = BSP	L	L2	D	SW	
350	6	1/4"	7/16"-20	1/8"-28	30.0	14.0	4.5	14	1252532-04-02
350	6	1/4"	7/16"-20	1/4"-19	35.0	14.0	4.5	19	1252532-04-04
350	8	5/16"	1/2"-20	1/8"-28	30.0	14.0	5.0	14	1252532-05-02
350	8	5/16"	1/2"-20	1/4"-19	35.0	14.0	6.0	19	1252532-05-04
350	10	3/8"	9/16"-18	1/4"-19	35.5	14.0	7.5	19	1252532-06-04
350	10	3/8"	9/16"-18	3/8"-19	37.0	14.0	7.5	22	1252532-06-06
350	12	1/2"	3/4"-16	3/8"-19	39.5	17.0	10.0	22	1252532-08-06
350	12	1/2"	3/4"-16	1/2"-14	45.5	17.0	10.0	27	1252532-08-08
350	14, 15, 16	5/8"	7/8"-14	1/2"-14	48.0	19.5	12.5	27	1252532-10-08
315	18, 20	3/4"	1 1/16"-12	3/4"-14	52.0	22.0	15.5	36	1252532-12-12
280	25	1"	1 5/8"-12	1"-11	59.5	23.0	21.5	41	1252532-16-16
210	28, 30, 32	1 1/4"	1 5/8"-12	1 1/4"-11	63.0	24.3	27.5	50	1252532-20-20
140	35, 38	1 1/2"	1 7/8"-12	1 1/2"-11	66.5	27.5	33.0	55	1252532-24-24