

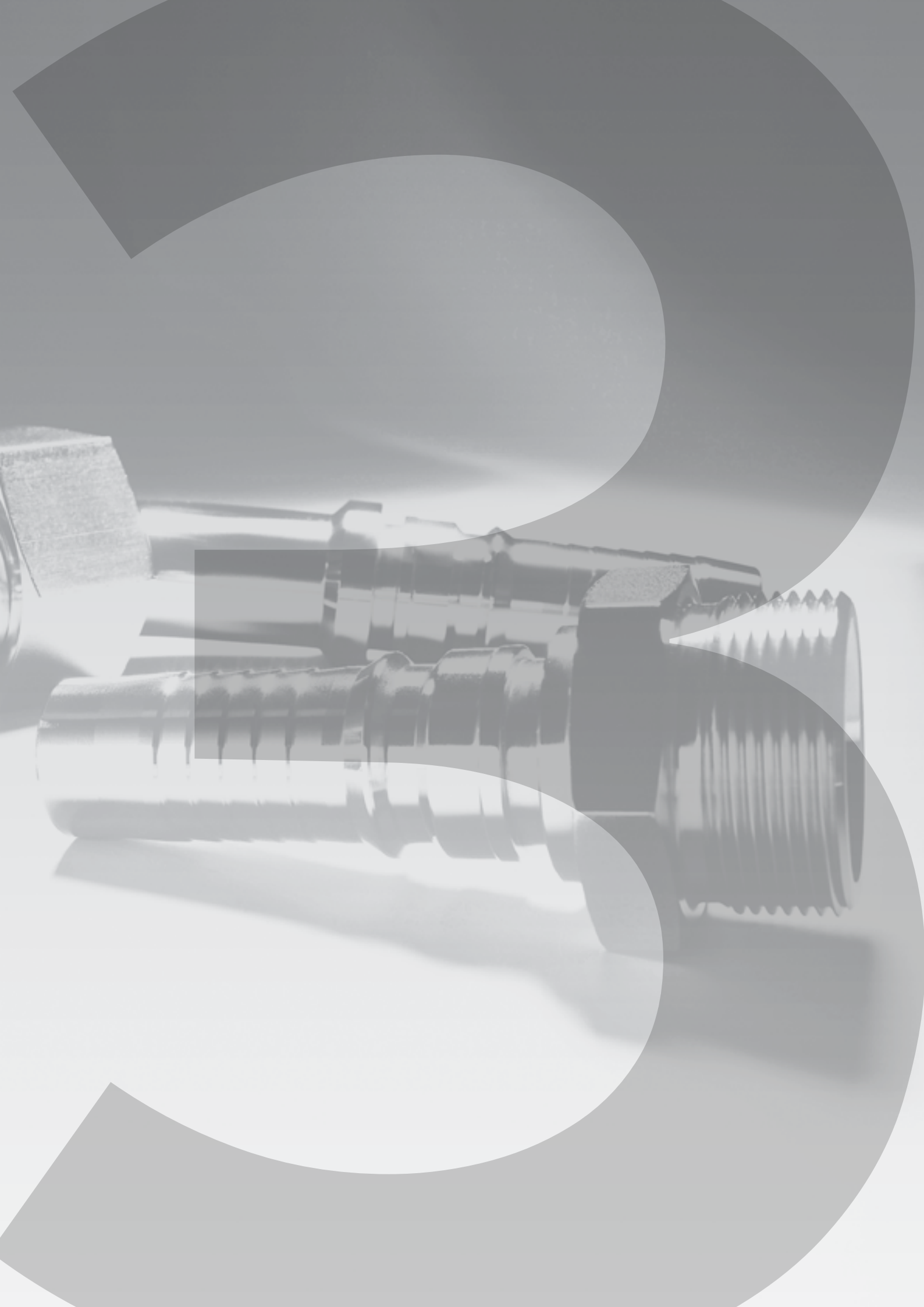











Interlock hose inserts



3



	Product Groups	Page
	Interlock ferrules	
	Ferrules - P4-I	3.02
	Ferrules - P6-I	3.03
	Ferrules - P7-I	3.04
	Interlock fittings - I-SFL & I-SFS (SAE flange)	
	Straight	3.05
	45°-Elbow	3.06
	90°-Elbow	3.07
	Interlock fittings - I-DKOL (metric DIN 2353 L-series female)	
	Straight	3.08
	45°-Elbow	3.09
	90°-Elbow	3.10
	Interlock fittings - I-DKOS (metric DIN 2353 S-series female)	
	Straight	3.11
	45°-Elbow	3.12
	90°-Elbow	3.13
	Interlock fittings - I-DKJ (JIC female)	
	Straight	3.14
	45°-Elbow	3.15
	90°-Elbow	3.16
	Interlock fittings - I-DKOR (BSPP swivel female with O-ring)	
	Straight	3.17
	45°-Elbow	3.18
	90°-Elbow	3.19
	Interlock fittings - I-CES (DIN 2353 compression male)	3.20
	Interlock fittings - I-AGR (BSPP 60° coned male)	3.21
	Interlock fittings - I-AGJ (37° JIC male)	3.22
	Interlock fittings - I-AGN (NPT male)	3.23

Interlock series, for high pressures.

For use with 4SP, 4SH or R12 hydraulic hose, depending on size.

Please check below table.

For use with Interlock hose inserts pp. 3.05-3.23 only.

Hoses must be skived internally and externally.

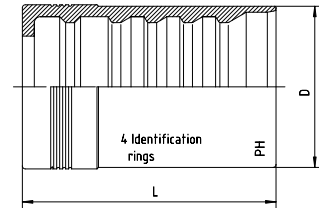

Hose DN	Bore in.	For Hose Type		Part code	
		D	L		
19	3/4"	38	56	4 SP + 4 SH	P4-I-DN 19
25	1"	46	75	4 SP + 4 SH + R12	P4-I-DN 25
31	1 1/4"	55	85	4 SH	P4-I-DN 31
38	1 1/2"	64	100	4 SH	P4-I-DN 38
51	2"	78	103	4 SH	P4-I-DN 51

Interlock series, for high pressures.

For use with R13 hydraulic hose.

For use with Interlock hose inserts pp. 3.05-3.23 only.

Hoses must be skived internally and externally.

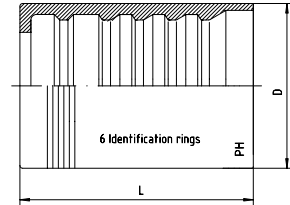

3

Hose DN	Bore in.	D	L	For Hose Type	Part code
19	3/4"	38.0	56	R13	P6-I-DN 19
25	1"	46.0	75	R13	P6-I-DN 25
31	1 1/4"	60.0	85	R13	P6-I-DN 31
38	1 1/2"	70.0	100	R13	P6-I-DN 38
51	2"	84.5	103	R13	P6-I-DN 51

Interlock Ferrules

BOOK INDEX

SECTION INDEX

Interlock series, for high pressures.

For use with R15 hydraulic hose.

For use with Interlock hose inserts pp. 3.05-3.23 only.

Hoses must be skived internally and externally.

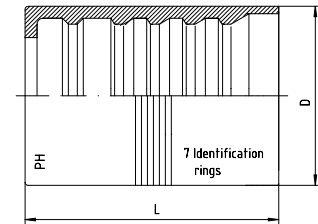

3

Hose DN	Bore in.	D	L	For Hose Type	Part code
19	3/4"	38	56	R15	P7-I-DN 19
25	1"	46	75	R15	P7-I-DN 25
31	1 1/4"	60	85	R15	P7-I-DN 31
38	1 1/2"	70	100	R15	P7-I-DN 38

Interlock series, for high pressures.

SAE ISO flange connection - Straight

I-SFL3 = 3000 psi ("Code 61" flange)

I-SFS6 = 6000 psi ("Code 62" flange)

Specifically designed for use with ferrules

P4, P6 or P7 - pp. 3.02 to 3.04.

Hoses must be skived internally and externally.

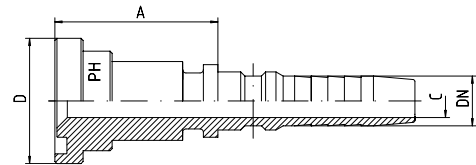

3

3,000 psi series

Hose DN	Bore in.	Flange Dimensions		Approx. Dimensions			Part code
		D	in.	A		C	
19	3/4"	38.1	3/4"	41.0		14.5	I-SFL3-3/4"-DN 19
19	3/4"	44.5	1"	44.5		14.5	I-SFL3-1"-DN 19
25	1"	44.5	1"	52.5		20.0	I-SFL3-1"-DN 25
25	1"	50.8	1 1/4"	53.0		20.0	I-SFL3-1 1/4"-DN 25
31	1 1/4"	50.8	1 1/4"	53.0		25.0	I-SFL3-1 1/4"-DN 31
31	1 1/4"	60.3	1 1/2"	50.5		25.0	I-SFL3-1 1/2"-DN 31
38	1 1/2"	60.3	1 1/2"	77.5		31.5	I-SFL3-1 1/2"-DN 38
38	1 1/2"	71.4	2"	72.0		31.5	I-SFL3-2"-DN 38
51	2"	71.4	2"	72.0		42.0	I-SFL3-2"-DN 51

6,000 psi series

Hose DN	Bore in.	Flange Dimensions		Approx. Dimensions			Part code
		D	in.	A		C	
19	3/4"	41.3	3/4"	52.0		14.5	I-SFS6-3/4"-DN 19
25	1"	41.3	3/4"	47.5		20.0	I-SFS6-3/4"-DN 25
19	3/4"	47.6	1"	44.5		14.5	I-SFS6-1"-DN 19
25	1"	47.6	1"	64.0		20.0	I-SFS6-1"-DN 25
31	1 1/4"	47.6	1"	60.0		20.0	I-SFS6-1"-DN 31
25	1"	54.0	1 1/4"	54.5		20.0	I-SFS6-1 1/4"-DN 25
31	1 1/4"	54.0	1 1/4"	75.0		25.0	I-SFS6-1 1/4"-DN 31
38	1 1/2"	54.0	1 1/4"	105.0		25.0	I-SFS6-1 1/4"-DN 38
31	1 1/4"	63.5	1 1/2"	75.5		25.0	I-SFS6-1 1/2"-DN 31
38	1 1/2"	63.5	1 1/2"	103.0		31.5	I-SFS6-1 1/2"-DN 38
38	1 1/2"	79.4	2"	75.0		31.5	I-SFS6-2"-DN 38
51	2"	79.4	2"	85.0		42.0	I-SFS6-2"-DN 51

Interlock series, for high pressures.

SAE ISO flange connection - swept 45°

I-SFL3 = 3000 psi ("Code 61" flange)

I-SFS6 = 6000 psi ("Code 62" flange)

Specifically designed for use with ferrules

P4, P6 or P7 - pp. 3.02 to 3.04.

Hoses must be skived internally and externally.

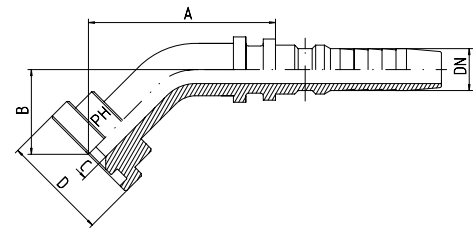

3

3,000 psi series

Hose DN	Bore in.	Flange Dimensions		Approx. Dimensions			Part code
		D	in.	A	B	C	
19	3/4"	38.1	3/4"	87.0	38.0	14.5	I-SFL3-3/4"-45°-DN 19
19	3/4"	44.5	1"	89.0	39.5	14.5	I-SFL3-1"-45°-DN 19
25	1"	44.5	1"	92.0	39.0	20.0	I-SFL3-1"-45°-DN 25
25	1"	50.8	1 1/4"	117.0	44.0	20.0	I-SFL3-1 1/4"-45°-DN 25
31	1 1/4"	50.8	1 1/4"	110.0	45.0	25.0	I-SFL3-1 1/4"-45°-DN 31
31	1 1/4"	60.3	1 1/2"	137.0	46.0	25.0	I-SFL3-1 1/2"-45°-DN 31
38	1 1/2"	60.3	1 1/2"	133.0	49.0	31.0	I-SFL3-1 1/2"-45°-DN 38
38	1 1/2"	71.4	2"	141.5	60.0	31.0	I-SFL3-2"-45°-DN 38
51	2"	71.4	2"	155.0	65.0	41.0	I-SFL3-2"-45°-DN 51

6,000 psi series

Hose DN	Bore in.	Flange Dimensions		Approx. Dimensions			Part code
		D	in.	A	B	C	
19	3/4"	41.3	3/4"	86.0	34.0	14.5	I-SFS6-3/4"-45°-DN 19
25	1"	41.3	3/4"	89.5	41.0	19.0	I-SFS6-3/4"-45°-DN 25
19	3/4"	47.6	1"	90.0	40.0	14.5	I-SFS6-1"-45°-DN 19
25	1"	47.6	1"	92.0	40.0	20.0	I-SFS6-1"-45°-DN 25
25	1"	54.0	1 1/4"	120.0	44.0	20.0	I-SFS6-1 1/4"-45°-DN 25
31	1 1/4"	54.0	1 1/4"	110.0	46.0	25.0	I-SFS6-1 1/4"-45°-DN 31
31	1 1/4"	63.5	1 1/2"	137.0	48.0	25.0	I-SFS6-1 1/2"-45°-DN 31
38	1 1/2"	63.5	1 1/2"	133.0	48.0	31.0	I-SFS6-1 1/2"-45°-DN 38
38	1 1/2"	79.4	2"	143.0	65.0	31.0	I-SFS6-2"-45°-DN 38
51	2"	79.4	2"	155.0	65.0	41.0	I-SFS6-2"-45°-DN 51

Interlock series, for high pressures.

SAE ISO flange connection - swept 90°

I-SFL3 = 3000 psi ("Code 61" flange)

I-SFS6 = 6000 psi ("Code 62" flange)

Specifically designed for use with ferrules

P4, P6 or P7 - pp. 3.02 to 3.04.

Hoses must be skived internally and externally.

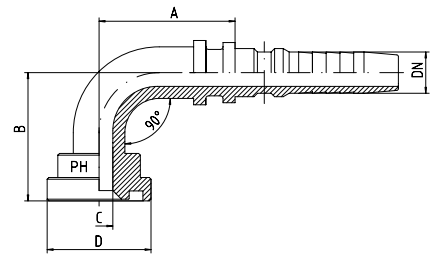

3

3,000 psi series

Hose DN	Bore in.	Flange Dimensions		Approx. Dimensions			Part code
		D	in.	A	B	C	
19	3/4"	38.1	3/4"	78.0	70.0	14.5	I-SFL3-3/4"-90°-DN 19
19	3/4"	44.5	1"	77.0	71.0	14.5	I-SFL3-1"-90°-DN 19
25	1"	44.5	1"	82.0	75.0	20.0	I-SFL3-1"-90°-DN 25
25	1"	50.8	1 1/4"	105.0	88.0	20.0	I-SFL3-1 1/4"-90°-DN 25
31	1 1/4"	50.8	1 1/4"	102.0	91.5	25.0	I-SFL3-1 1/4"-90°-DN 31
31	1 1/4"	60.3	1 1/2"	123.0	95.0	25.0	I-SFL3-1 1/2"-90°-DN 31
38	1 1/2"	60.3	1 1/2"	122.5	105.0	31.0	I-SFL3-1 1/2"-90°-DN 38
38	1 1/2"	71.4	2"	124.0	121.0	31.0	I-SFL3-2"-90°-DN 38
51	2"	71.4	2"	144.0	137.0	41.0	I-SFL3-2"-90°-DN 51

6,000 psi series

Hose DN	Bore in.	Flange Dimensions		Approx. Dimensions			Part code
		D	in.	A	B	C	
19	3/4"	41.3	3/4"	78.0	67.0	14.5	I-SFS6-3/4"-90°-DN 19
25	1"	41.3	3/4"	80.0	81.5	19.0	I-SFS6-3/4"-90°-DN 25
19	3/4"	47.6	1"	77.0	72.0	14.5	I-SFS6-1"-90°-DN 19
25	1"	47.6	1"	82.0	77.0	20.0	I-SFS6-1"-90°-DN 25
25	1"	54.0	1 1/4"	108.0	90.0	20.0	I-SFS6-1 1/4"-90°-DN 25
31	1 1/4"	54.0	1 1/4"	102.0	93.5	25.0	I-SFS6-1 1/4"-90°-DN 31
31	1 1/4"	63.5	1 1/2"	124.0	96.0	25.0	I-SFS6-1 1/2"-90°-DN 31
38	1 1/2"	63.5	1 1/2"	122.5	107.0	31.0	I-SFS6-1 1/2"-90°-DN 38
38	1 1/2"	79.4	2"	124.0	121.5	31.0	I-SFS6-2"-90°-DN 38
51	2"	79.4	2"	144.0	142.0	41.0	I-SFS6-2"-90°-DN 51

Interlock series, for high pressures.

DIN 2353 metric compression swivel female

L series - straight

ISO 8434-1 / DIN 2353

Specifically designed for use with ferrules

P4, P6 or P7 - pp. 3.02 to 3.04.

Hoses must be skived internally and externally.

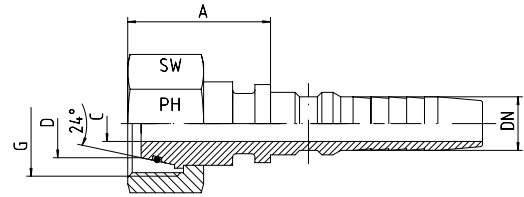

3

Hose DN	Bore in.	Thread G	Tube O.D. D	Approx. Dimensions			Part code
				A	C	SW	
19	3/4"	M 30 x 2	22	38.5	14.5	36	I-DKOL-22-DN 19
25	1"	M 36 x 2	28	38.0	20.0	41	I-DKOL-28-DN 25
31	1 1/4"	M 45 x 2	35	42.0	25.0	50	I-DKOL-35-DN 31
38	1 1/2"	M 52 x 2	42	41.0	31.5	60	I-DKOL-42-DN 38

Interlock series, for high pressures.

DIN 2353 metric compression swivel female

L series - swept 45°

ISO 8434-1 / DIN 2353

Specifically designed for use with ferrules

P4, P6 or P7 - pp. 3.02 to 3.04.

Hoses must be skived internally and externally.

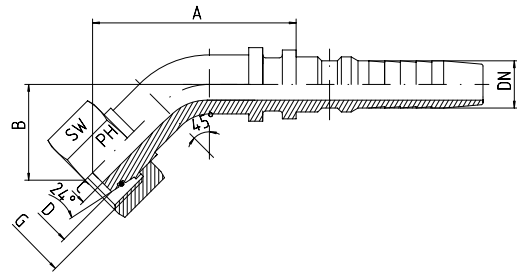

3

Hose DN	Bore in.	Thread G	Tube O.D. D	Approx. Dimensions				Part code
				A	B	C	SW	
19	3/4"	M 30 x 2	22	95	45	14.5	36	I-DKOL-22-45°-DN 19
25	1"	M 36 x 2	28	102	50	20.0	41	I-DKOL-28-45°-DN 25
31	1 1/4"	M 45 x 2	35	120	50	25.0	50	I-DKOL-35-45°-DN 31
38	1 1/2"	M 52 x 2	42	140	61	31.0	60	I-DKOL-42-45°-DN 38

Interlock series, for high pressures.

DIN 2353 metric compression swivel female

L series - swept 90°

ISO 8434-1 / DIN 2353

Specifically designed for use with ferrules

P4, P6 or P7 - pp. 3.02 to 3.04.

Hoses must be skived internally and externally.

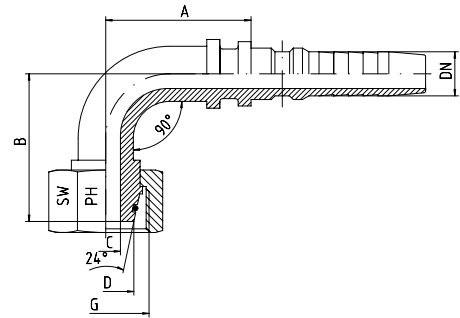

3

Hose DN	Bore in.	Thread G	Tube O.D. D	Approx. Dimensions				Part code
				A	B	C	SW	
19	3/4"	M 30 x 2	22	78.5	80	14.5	36	I-DKOL-22-90°-DN 19
25	1"	M 36 x 2	28	87.0	92	20.0	41	I-DKOL-28-90°-DN 25
31	1 1/4"	M 45 x 2	35	103.0	98	25.0	50	I-DKOL-35-90°-DN 31
38	1 1/2"	M 52 x 2	42	124.0	117	31.0	60	I-DKOL-42-90°-DN 38

Interlock series, for high pressures.

DIN 2353 metric compression swivel female

S series - straight

ISO 8434-1 / DIN 2353

Specifically designed for use with ferrules

P4, P6 or P7 - pp. 3.02 to 3.04.

Hoses must be skived internally and externally.

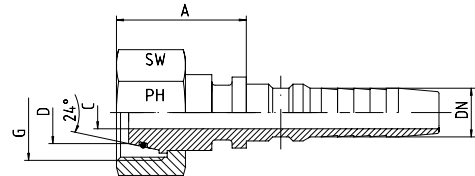

3

Hose DN	Bore in.	Thread G	Tube O.D. D	Approx. Dimensions			Part code
				A	C	SW	
19	3/4"	M 30 x 2	20	34.5	14.5	36	I-DKOS-20-DN 19
19	3/4"	M 36 x 2	25	41.0	14.5	46	I-DKOS-25-DN 19
25	1"	M 36 x 2	25	38.5	20.0	46	I-DKOS-25-DN 25
25	1"	M 42 x 2	30	43.5	20.0	50	I-DKOS-30-DN 25
31	1 1/4"	M 42 x 2	30	43.0	23.0	50	I-DKOS-30-DN 31
31	1 1/4"	M 52 x 2	38	48.5	25.0	60	I-DKOS-38-DN 31
38	1 1/2"	M 52 x 2	38	41.0	28.0	60	I-DKOS-38-DN 38
38	1 1/2"	M 68 x 2	50	51.5	31.5	80	I-DKOS-50-DN 38

Interlock series, for high pressures.

DIN 2353 metric compression swivel female

S series - swept 45°

ISO 8434-1 / DIN 2353

Specifically designed for use with ferrules

P4, P6 or P7 - pp. 3.02 to 3.04.

Hoses must be skived internally and externally.

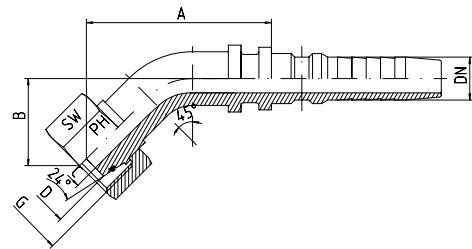

3

Hose DN	Bore in.	Thread G	Tube O.D. D	Approx. Dimensions				Part code
				A	B	C	SW	
19	3/4"	M 30 x 2	20	100	45	14.5	36	I-DKOS-20-45°-DN 19
19	3/4"	M 36 x 2	25	90	40	14.5	46	I-DKOS-25-45°-DN 19
25	1"	M 36 x 2	25	103	52	20.0	46	I-DKOS-25-45°-DN 25
25	1"	M 42 x 2	30	97	43	20.0	50	I-DKOS-30-45°-DN 25
31	1 1/4"	M 52 x 2	38	117	52	25.0	60	I-DKOS-38-45°-DN 31
38	1 1/2"	M 68 x 2	50	136	53	31.0	80	I-DKOS-50-45°-DN 38

Interlock series, for high pressures.

DIN 2353 metric compression swivel female

S series - swept 90°

ISO 8434-1 / DIN 2353

Specifically designed for use with ferrules

P4, P6 or P7 - pp. 3.02 to 3.04.

Hoses must be skived internally and externally.

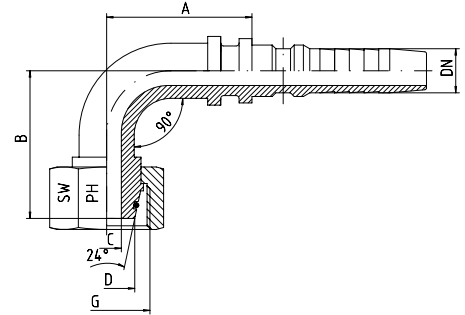

3

Hose DN	Bore in.	Thread G	Tube O.D. D	Approx. Dimensions				Part code
				A	B	C	SW	
19	3/4"	M 30 x 2	20	78.5	83.0	14.5	36	I-DKOS-20-90°-DN 19
19	3/4"	M 36 x 2	25	75.0	76.0	14.5	46	I-DKOS-25-90°-DN 19
25	1"	M 36 x 2	25	84.0	95.5	20.0	46	I-DKOS-25-90°-DN 25
25	1"	M 42 x 2	30	84.0	83.0	20.0	50	I-DKOS-30-90°-DN 25
31	1 1/4"	M 52 x 2	38	103.0	101.0	25.0	60	I-DKOS-38-90°-DN 31
38	1 1/2"	M 68 x 2	50	125.0	111.0	31.0	80	I-DKOS-50-90°-DN 38

JIC 37° Swivel Female Interlock Insert

BOOK INDEX

SECTION INDEX

Interlock series, for high pressures.

37° JIC swivel female - straight

ISO 8434-2 / J514

Specifically designed for use with ferrules

P4, P6 or P7 - pp. 3.02 to 3.04.

Hoses must be skived internally and externally.

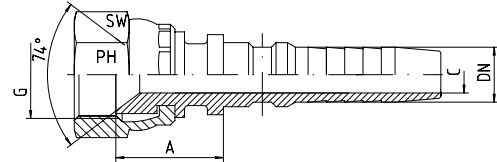

3

Hose DN	Bore in.	Thread G = UN	Approx. Dimensions			Part code
			A	C	SW	
19	3/4"	1 1/16"-12	35.0	14.5	32	I-DKJ-1 1/16"-DN 19
19	3/4"	1 5/16"-12	34.0	14.5	41	I-DKJ-1 5/16"-DN 19
25	1"	1 5/16"-12	34.0	20.0	41	I-DKJ-1 5/16"-DN 25
25	1"	1 5/8"-12	27.0	20.0	50	I-DKJ-1 5/8"-DN 25
31	1 1/4"	1 5/8"-12	37.0	25.0	50	I-DKJ-1 5/8"-DN 31
31	1 1/4"	1 7/8"-12	33.0	25.0	60	I-DKJ-1 7/8"-DN 31
38	1 1/2"	1 7/8"-12	41.5	31.5	60	I-DKJ-1 7/8"-DN 38
38	1 1/2"	2 1/2"-12				I-DKJ-2 1/2"-DN 38
51	2"	2 1/2"-12	67.5	42.0	70	I-DKJ-2 1/2"-DN 51

JIC 37° Swivel Female Interlock Insert

BOOK INDEX

SECTION INDEX

Interlock series, for high pressures.

37° JIC swivel female - swept 45°

ISO 8434-2 / J514

Specifically designed for use with ferrules

P4, P6 or P7 - pp. 3.02 to 3.04.

Hoses must be skived internally and externally.

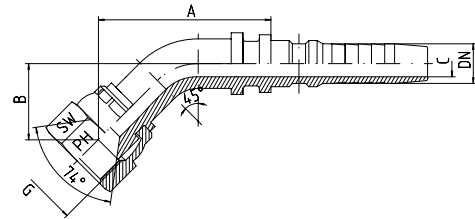

3

Hose DN	Bore in.	Thread G = UN	Approx. Dimensions				Part code
			A	B	C	SW	
19	3/4"	1 1/16"-12	93.0	37.5	14.5	32	I-DKJ-1 1/16"-45°-DN 19
19	3/4"	1 5/16"-12	93.0	43.5	14.5	41	I-DKJ-1 5/16"-45°-DN 19
25	1"	1 5/16"-12	101.0	47.0	20.0	41	I-DKJ-1 5/16"-45°-DN 25
25	1"	1 5/8"-12	123.0	51.0	20.0	50	I-DKJ-1 5/8"-45°-DN 25
31	1 1/4"	1 5/8"-12	116.5	49.0	25.0	50	I-DKJ-1 5/8"-45°-DN 31
31	1 1/4"	1 7/8"-12	146.0	52.0	25.0	60	I-DKJ-1 7/8"-45°-DN 31
38	1 1/2"	1 7/8"-12	130.0	50.0	31.0	60	I-DKJ-1 7/8"-45°-DN 38
38	1 1/2"	2 1/2"-12					I-DKJ-2 1/2"-45°-DN 38
51	2"	2 1/2"-12	166.5	78.0	41.0	70	I-DKJ-2 1/2"-45°-DN 51

JIC 37° Swivel Female Interlock Insert

BOOK INDEX

SECTION INDEX

Interlock series, for high pressures.

37° JIC swivel female - swept 90°

ISO 8434-2 / J514

Specifically designed for use with ferrules

P4, P6 or P7 - pp. 3.02 to 3.04.

Hoses must be skived internally and externally.

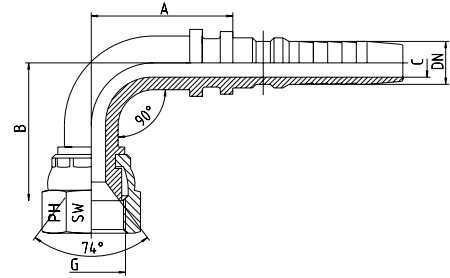

3

Hose DN	Bore in.	Thread G = UN	Approx. Dimensions				Part code
			A	B	C	SW	
19	3/4"	1 1/16"-12	79	72.0	14.5	32	I-DKJ-1 1/16"-90°-DN 19
19	3/4"	1 5/16"-12	78	79.0	14.5	41	I-DKJ-1 5/16"-90°-DN 19
25	1"	1 5/16"-12	85	86.0	20.0	41	I-DKJ-1 5/16"-90°-DN 25
25	1"	1 5/8"-12	107	93.0	20.0	50	I-DKJ-1 5/8"-90°-DN 25
31	1 1/4"	1 5/8"-12	103	96.0	25.0	50	I-DKJ-1 5/8"-90°-DN 31
31	1 1/4"	1 7/8"-12	125	98.0	25.0	60	I-DKJ-1 7/8"-90°-DN 31
38	1 1/2"	1 7/8"-12	122	107.0	31.0	60	I-DKJ-1 7/8"-90°-DN 38
38	1 1/2"	2 1/2"-12					I-DKJ-2 1/2"-90°-DN 38
51	2"	2 1/2"-12	145	151.5	41.0	70	I-DKJ-2 1/2"-90°-DN 51

BSPP 60° Swivel Female (with O-ring) Interlock Insert

BOOK INDEX

SECTION INDEX

Interlock series, for high pressures.

BSPP O-ring 60° coned swivel female - straight

Specifically designed for use with ferrules

P4, P6 or P7 - pp. 3.02 to 3.04.

Hoses must be skived internally and externally.

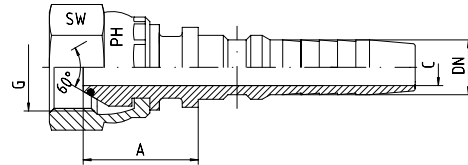

3

Hose DN	Bore in.	Thread G	Approx. Dimensions			Part code
			A	C	SW	
19	3/4"	3/4"-14	32	14.5	32	I-DKOR-3/4"-DN 19
25	1"	1"-11	39	20.0	41	I-DKOR-1"-DN 25
31	1 1/4"	1 1/4"-11	42	25.0	50	I-DKOR-1 1/4"-DN 31
38	1 1/2"	1 1/2"-11	40	31.5	60	I-DKOR-1 1/2"-DN 38
51	2"	2"-11	39	42.0	70	I-DKOR-2"-DN 51

BSPP 60° Swivel Female (with O-ring) Interlock Insert

BOOK INDEX

SECTION INDEX

Interlock series, for high pressures.

BSPP O-ring 60° coned swivel female - swept 45°

Specifically designed for use with ferrules

P4, P6 or P7 - pp. 3.02 to 3.04.

Hoses must be skived internally and externally.

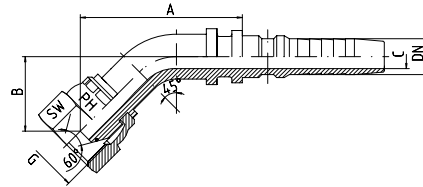

3

Hose DN	Bore in.	Thread G	Approx. Dimensions				Part code
			A	B	C	SW	
19	3/4"	3/4"-14	90	39	14.5	32	I-DKOR-3/4"-45°-DN 19
25	1"	1"-11	97	46	20.0	41	I-DKOR-1"-45°-DN 25
31	1 1/4"	1 1/4"-11	117	52	25.0	50	I-DKOR-1 1/4"-45°-DN 31
38	1 1/2"	1 1/2"-11	134	49	31.0	60	I-DKOR-1 1/2"-45°-DN 38
51	2"	2"-11	170	81	41.0	70	I-DKOR-2"-45°-DN 51

BSPP 60° Swivel Female (with O-ring) Interlock Insert

BOOK INDEX

SECTION INDEX

Interlock series, for high pressures.

BSPP O-ring 60° coned swivel female - swept 90°

Specifically designed for use with ferrules

P4, P6 or P7 - pp. 3.02 to 3.04.

Hoses must be skived internally and externally.

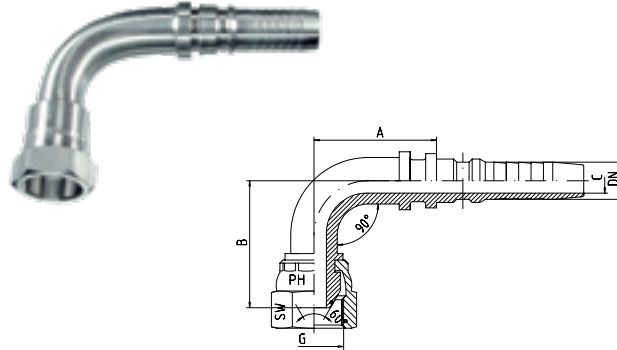

3

Hose DN	Bore in.	Thread G	Approx. Dimensions				Part code
			A	B	C	SW	
19	3/4"	3/4"-14	77	75	14.5	32	I-DKOR-3/4"-90°-DN 19
25	1"	1"-11	83	85	20.0	41	I-DKOR-1"-90°-DN 25
31	1 1/4"	1 1/4"-11	103	100	25.0	50	I-DKOR-1 1/4"-90°-DN 31
38	1 1/2"	1 1/2"-11	118	110	31.0	60	I-DKOR-1 1/2"-90°-DN 38
51	2"	2"-11	146	152	41.0	70	I-DKOR-2"-90°-DN 51

Interlock series, for high pressures.

DIN 2353 metric compression male

S series - straight

ISO 8434-1 / DIN 2353

Specifically designed for use with ferrules

P4, P6 or P7 - pp. 3.02 to 3.04.

Hoses must be skived internally and externally.

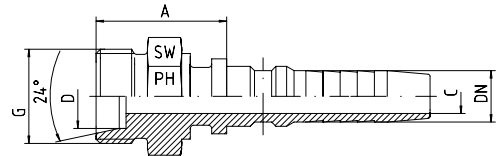

3

Hose DN	Bore in.	Thread G	Tube O.D. D	Approx. Dimensions			Part code
				A	C	SW	
19	3/4"	M 30 x 2	20	37.5	14.5	32	I-CES-20-DN 19
19	3/4"	M 36 x 2	25	36.0	14.5	36	I-CES-25-DN 19
25	1"	M 36 x 2	25	43.0	20.0	36	I-CES-25-DN 25
25	1"	M 42 x 2	30	40.0	20.0	46	I-CES-30-DN 25
31	1 1/4"	M 52 x 2	38	44.5	25.0	55	I-CES-38-DN 31

BSPP 60° Coned Male Interlock Insert

BOOK INDEX

SECTION INDEX

Interlock series, for high pressures.

BSPP 60° coned male - straight

ISO 8434-6 / BS 5200

Specifically designed for use with ferrules

P4, P6 or P7 - pp. 3.02 to 3.04.

Hoses must be skived internally and externally.

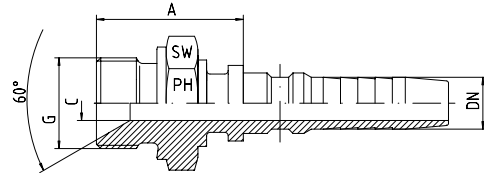

3

Hose DN	Bore in.	Thread G	Approx. Dimensions			Part code
			A	C	SW	
19	3/4"	3/4"-14	40.5	14.5	32	I-AGR-3/4"-DN 19
19	3/4"	1"-11	44.5	14.5	41	I-AGR-1"-DN 19
25	1"	1"-11	48.5	20.0	41	I-AGR-1"-DN 25
31	1 1/4"	1 1/4"-11	44.0	25.0	50	I-AGR-1 1/4"-DN 31
38	1 1/2"	1 1/2"-11	54.0	31.5	55	I-AGR-1 1/2"-DN 38
51	2"	2"-11	52.5	42.0	70	I-AGR-2"-DN 51

JIC 37° Male Interlock Insert

BOOK INDEX

SECTION INDEX

Interlock series, for high pressures.

37° JIC male - straight

ISO 8434-2 / J514

Specifically designed for use with ferrules

P4, P6 or P7 - pp. 3.02 to 3.04.

Hoses must be skived internally and externally.

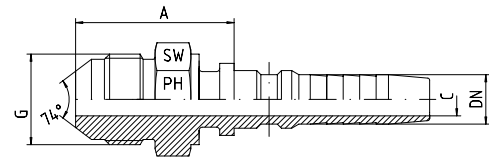

3

Hose DN	Bore in.	Thread G = UN	Approx. Dimensions			Part code
			A	C	SW	
19	3/4"	1 1/16"-12	48.5	14.5	30	I-AGJ-1 1/16"-DN 19
25	1"	1 5/16"-12	48.0	20.0	36	I-AGJ-1 5/16"-DN 25
31	1 1/4"	1 5/8"-12	48.0	25.0	46	I-AGJ-1 5/8"-DN 31
38	1 1/2"	1 7/8"-12	57.0	31.5	50	I-AGJ-1 7/8"-DN 38
51	2"	2 1/2"-12	60.0	42.0	65	I-AGJ-2 1/2"-DN 51

NPT Male Interlock Insert

BOOK INDEX

SECTION INDEX

Interlock series, for high pressures.

NPT 60° coned male - straight

Specifically designed for use with ferrules

P4, P6 or P7 - pp. 3.02 to 3.04.

Hoses must be skived internally and externally.

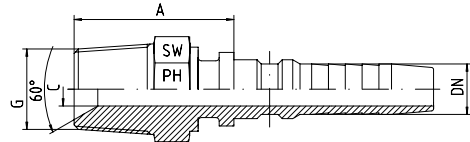

3

Hose DN	Bore in.	Thread G = NPT	Approx. Dimensions			Part code
			A	C	SW	
19	3/4"	3/4"-14	41.0	14.5	30	I-AGN-3/4"-DN 19
19	3/4"	1"-11.5		14.5	36	I-AGN-1"-DN 19
25	1"	1"-11.5	65.5	20.0	36	I-AGN-1"-DN 25
31	1 1/4"	1 1/4"-11.5	53.0	25.0	46	I-AGN-1 1/4"-DN 31
38	1 1/2"	1 1/2"-11.5	60.5	31.0	50	I-AGN-1 1/2"-DN 38
51	2"	2"-11.5	53.0	42.0	65	I-AGN-2"-DN 51